

3745 Communication Controller Models A  
3746 Nways Multiprotocol Controller Model 900

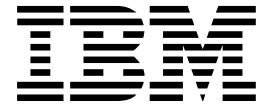

# Basic Operations Guide

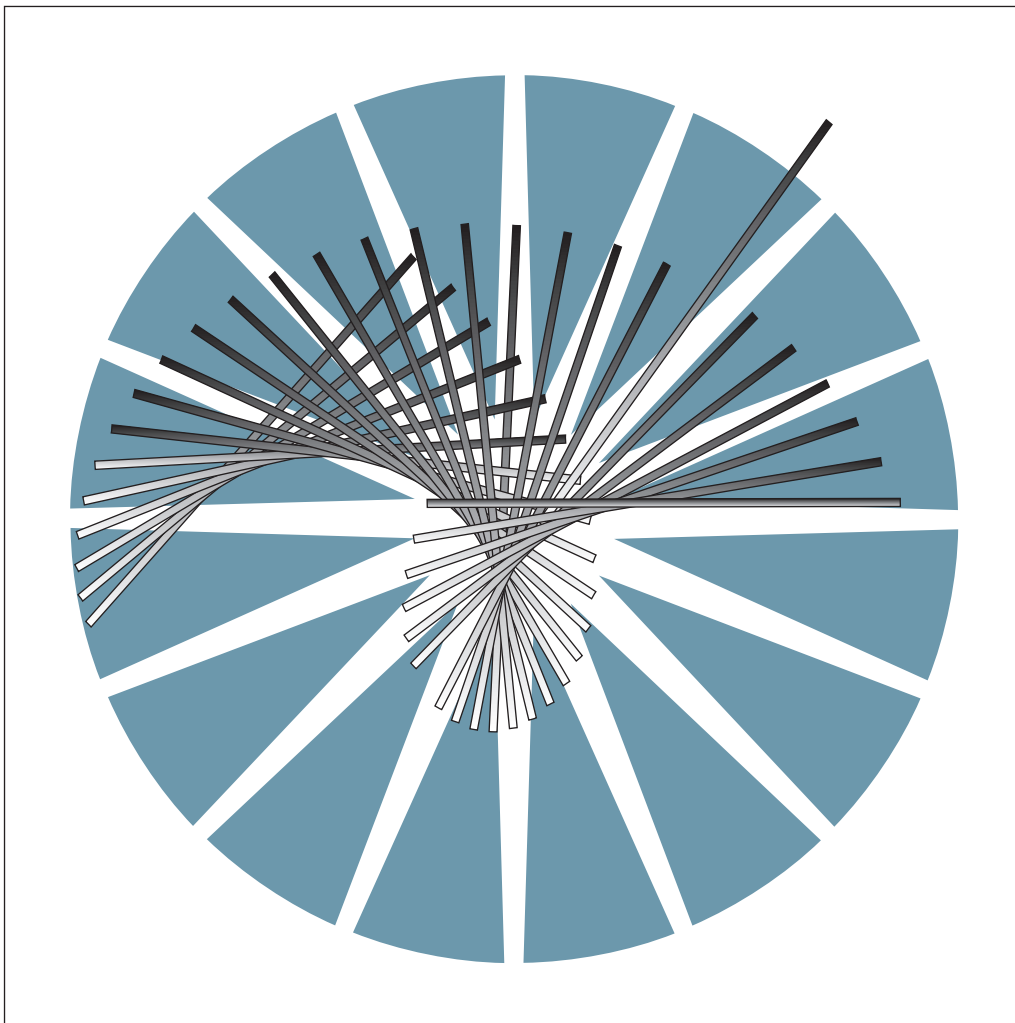



3745 Communication Controller Models A  
3746 Nways Multiprotocol Controller Model 900

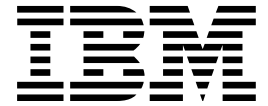

# Basic Operations Guide

**Note!**

Before using this information and the product it supports, be sure to read the general information under "Notices" on page ix.

**Seventh Edition (May 1998)**

The information contained in this manual is subject to change from time to time. Any such changes will be reported in later revisions.

Order publications through your IBM representative or the IBM branch office serving your locality. Publications are not stocked at the address given below.

A form for readers' comments appears at the back of this publication. If the form has been removed, address your comments to:

IBM France  
Centre d'Etudes et Recherches  
Service 0798 - BP 79  
06610 La Gaude  
France

- FAX: 33 4 93 24 77 97
- IBM Internal Use: LGERCF at IBMFR
- Internet: lgercf@fr.ibm.com

When you send information to IBM, you grant IBM a non-exclusive right to use or distribute the information in any way it believes appropriate without incurring any obligation to you.

© **Copyright International Business Machines Corporation 1993, 1998. All rights reserved.**

Note to U.S. Government Users — Documentation related to restricted rights — Use, duplication or disclosure is subject to restrictions set forth in GSA ADP Schedule Contract with IBM Corp.

---

# Contents

<b>Figures</b> .....	vii
<b>Notices</b> .....	ix
European Union (EU) Statement .....	ix
Electronic Emission Notices .....	ix
Trademarks and Service Marks .....	x
Safety .....	x
<b>About This Guide</b> .....	xi
Conventions Used in this Guide .....	xi
Who Should Use this Guide .....	xi
How this Guide is Organized .....	xii
What is New in this Guide .....	xiii
Where to Find More Information? .....	xiii
World Wide Web .....	xiii
<b>Chapter 1. General Information on 3745 and 3746 Controllers</b> .....	1-1
The IBM 3745 and 3746 Controllers Family .....	1-1
Getting Started .....	1-3
Locating Processors .....	1-3
Control Panels .....	1-4
Stop Switch for the 3745 .....	1-4
Solving Problems .....	1-5
Alarms .....	1-5
<b>Chapter 2. Service Processor</b> .....	2-1
Using the Service Processor .....	2-1
Connecting the Service Processor .....	2-1
Sharing the Service Processor .....	2-2
Using DCAF to Remotely Log On to the Service Processor .....	2-3
Remote Consoles .....	2-3
Backing Up the Service Processor .....	2-4
Setting Up a Backup Service Processor .....	2-4
Backing Up Configurations to a Backup Service Processor .....	2-4
Installing Microcode to a Backup Service Processor .....	2-6
Installing a Backup Service Processor .....	2-7
<b>Chapter 3. Maintenance and Operator Sub-System-Extended (MOSS-E)</b> ..	3-1
MOSS-E Passwords .....	3-2
Changing Passwords .....	3-3
Logging On to MOSS-E .....	3-4
Logging Off the MOSS-E .....	3-6
Program Pull-Down Menu .....	3-6
Window Pull-Down Menu .....	3-7
Information Pull-Down Menu .....	3-7
Help Pull-Down Menu .....	3-8
MOSS-E Menus, Tasks, and Functions .....	3-8
How to Use a Machine Menu .....	3-8
Problems with MOSS-E or the Service Processor .....	3-9
MOSS Window .....	3-10

How to Open the MOSS Window . . . . .	3-10
Service Processor MOSS Screen Layout . . . . .	3-10
Keyboard Terminology . . . . .	3-11
Common Commands and Function Keys . . . . .	3-12
Selecting MOSS Functions . . . . .	3-13
Menu 1 and 2 Functions . . . . .	3-14
Switching between Menu 1 and Menu 2 Functions . . . . .	3-15
How to Start and Stop Refresh . . . . .	3-16
How to Close MOSS . . . . .	3-16
Updating the Active CDF-E . . . . .	3-16
Backing up Controller Configurations . . . . .	3-18
<b>Chapter 4. Working with Network Node Processor (NNP) Functions . . . . .</b>	<b>4-1</b>
Accessing NNP Functions . . . . .	4-1
Manage Control Points on NNPs . . . . .	4-1
NNP Status . . . . .	4-4
Controller Configuration and Management (CCM) . . . . .	4-9
IP Commands . . . . .	4-10
Dual NNP . . . . .	4-10
NNP States . . . . .	4-10
<b>Chapter 5. Working with Multiaccess Enclosure (MAE) Functions . . . . .</b>	<b>5-1</b>
Introduction to the MAE . . . . .	5-1
Basic Functions in the MAE . . . . .	5-1
Prerequisites for MAE . . . . .	5-1
MAE with Direct Attachment . . . . .	5-1
MAE Configurations in CCM . . . . .	5-2
Using the MAE Configuration Program . . . . .	5-3
Accessing MAE Functions . . . . .	5-4
Install/Remove/Change LIC on MAE . . . . .	5-4
ASCII Console . . . . .	5-5
Perform Maintenance on MAE . . . . .	5-5
Selective IML on MAE . . . . .	5-6
Additional Information . . . . .	5-6
<b>Chapter 6. Telnet IP Resource Management in CCM and MOSS-E . . . . .</b>	<b>6-1</b>
Controller Configuration and Management (CCM) . . . . .	6-1
CCM and Telnet User Profiles . . . . .	6-1
CCM IP Resource Management . . . . .	6-2
Accessing IP Commands from the MOSS-E . . . . .	6-4
Navigating in the IP Environment . . . . .	6-4
OPCON Commands . . . . .	6-5
Configuring Resources . . . . .	6-5
Managing Resources . . . . .	6-6
Single IP Control Point for the 3746 and the MAE . . . . .	6-7
MONITR Process . . . . .	6-7
<b>Chapter 7. 3745 Power ON and IPL from Control Panel . . . . .</b>	<b>7-1</b>
3745 Manual Power ON and IPL . . . . .	7-1
3745 Automatic Power ON and IPL . . . . .	7-6
<b>Chapter 8. 3745 IPL from Service Processor . . . . .</b>	<b>8-1</b>
Power Supply of CA or IPL Port . . . . .	8-4
Troubleshooting Channel Adapters and IPL Ports . . . . .	8-4

Information Displayed on the MOSS Screen during IPL . . . . .	8-6
<b>Chapter 9. 3745 Models 41A and 61A Fallback and Switchback . . . . .</b>	<b>9-1</b>
Fallback . . . . .	9-1
Switchback . . . . .	9-3
<b>Chapter 10. Enabling and Disabling Channel Adapters . . . . .</b>	<b>10-1</b>
Enabling and Disabling 3745 Channel Adapters . . . . .	10-1
Enabling and Disabling 3746-900 ESCON Channel Adapters . . . . .	10-2
Verifying an ESCON Coupler Status . . . . .	10-2
Verifying a Link IPL Port . . . . .	10-4
<b>Chapter 11. Basic Service Procedures . . . . .</b>	<b>11-1</b>
3745 MOSS IML from the Service Processor . . . . .	11-1
3745 Scanner (Line Adapter) IML . . . . .	11-2
MOSS IML from the 3745 Control Panel . . . . .	11-4
3746 Power State . . . . .	11-6
Power Control Mode Switching . . . . .	11-6
Switching from Remote to Local (1 to 3) . . . . .	11-7
Switching from Local to Remote (3 to 1) . . . . .	11-7
Activation/Deactivation from the Service Processor . . . . .	11-7
Activation . . . . .	11-7
Deactivation . . . . .	11-8
Activation/Deactivation from a Host . . . . .	11-9
Power ON Command . . . . .	11-9
Power OFF Command . . . . .	11-9
VTAM Remote Power OFF Command . . . . .	11-9
Activation and IML from the 3746 Operator Control Panel . . . . .	11-10
Deactivation from the 3746 Operator Control Panel . . . . .	11-13
Auto-Restart after a Power Failure . . . . .	11-14
<b>Appendix A. 3745 Operator Control Panel . . . . .</b>	<b>A-1</b>
Function Display . . . . .	A-3
Function Numbers . . . . .	A-3
Code Display . . . . .	A-4
Service Mode Display . . . . .	A-4
Power Control Display . . . . .	A-5
Console in Use Display . . . . .	A-6
All 3745 CAs Disabled Indicator . . . . .	A-6
MOSS Inop Indicator . . . . .	A-6
MOSS Message Indicator . . . . .	A-7
Pushbuttons and Power ON Indicator . . . . .	A-7
Stop Switch . . . . .	A-8
Hexadecimal Codes . . . . .	A-9
<b>Appendix B. 3746 Operator Control Panel . . . . .</b>	<b>B-1</b>
Function Display . . . . .	B-1
Specific Button Selections . . . . .	B-2
Selections Using the Function Button . . . . .	B-2
Hexadecimal Codes . . . . .	B-3
Service Mode . . . . .	B-3
Power Control . . . . .	B-4
All ESCON Channel Adapters Disabled . . . . .	B-4
Service Processor Inaccessible . . . . .	B-5

<b>Appendix C. Bibliographies</b> .....	C-1
Customer Documentation for the 3745 (Models 210, 310, 410, 610, 21A, 31A, 41A, and 61A), and 3746 (Model 900) .....	C-1
Additional Customer Documentation for the 3745 Models 130, 150, 160, 170, and 17A .....	C-5
<b>List of Abbreviations</b> .....	X-1
<b>Glossary</b> .....	X-3
<b>Index</b> .....	X-7



---

# Figures

1-1.	The Networking Evolution of IBM 3745 and 3746 Controllers	1-2
1-2.	3745 Model A or 3746 with Controller Expansion	1-3
1-3.	IBM 3745 Control Panel	1-5
2-1.	Example 1 of a Maximum Configuration	2-2
2-2.	Example 2 of a Maximum Configuration	2-2
3-1.	MOSS-E View Window with Machine Menus	3-1
3-2.	General Format of a MOSS Screen	3-11
3-3.	Function Selection Rules Screen	3-13
3-4.	Menu 1 Functions	3-14
3-5.	Menu 2 Functions	3-14
3-6.	Resource Locator screen	3-17
4-1.	Dual Network Node Processors	4-10
5-1.	Controller Configuration and Management (CCM) Main Window	5-2
6-1.	Controller Configuration and Management (CCM) Main Window	6-3
6-2.	Internet Protocol (IP) Environment	6-5
A-1.	3745 Control Panel	A-1
A-2.	3745 Control Panel Reference Card	A-2
A-3.	IBM 3745 Control Panel	A-8
B-1.	3746 Control Panel	B-1



---

## Notices

References in this publication to IBM products, programs, or services do not imply that IBM intends to make these available in all countries in which IBM operates. Any reference to an IBM product, program, or service is not intended to state or imply that only IBM's product, program, or service may be used. Any functionally equivalent product, program, or service that does not infringe any of IBM's intellectual property rights may be used instead of the IBM product, program, or service. Evaluation and verification of operation in conjunction with other products, except those expressly designated by IBM, is the user's responsibility.

IBM may have patents or pending patent applications covering subject matter in this document. The furnishing of this document does not give you any license to these patents. You can send license inquiries, in writing, to the IBM Director of Licensing, IBM Corporation, 500 Columbus Avenue, Thornwood, New York 10594, U.S.A.

---

## European Union (EU) Statement

This product is in conformity with the protection requirements of EU Council Directive 89/336/EEC on the approximation of the laws of the Member States relating to electromagnetic compatibility. IBM can not accept responsibility for any failure to satisfy the protection requirements resulting from a non-recommended modification of the product, including the fitting of non-IBM option cards.

---

## Electronic Emission Notices

### Federal Communications Commission (FCC) Statement

**Note:** This equipment has been tested and found to comply with the limits for a Class A digital device, pursuant to Part 15 of the FCC Rules. These limits are designed to provide reasonable protection against harmful interference when the equipment is operated in a commercial environment. This equipment generates, uses, and can radiate radio frequency energy and, if not installed and used in accordance with the instruction manual, may cause harmful interference to radio communications. Operation of this equipment in a residential area is likely to cause harmful interference, in which case the user will be required to correct the interference at his own expense.

Properly shielded and grounded cables and connectors must be used in order to meet FCC emission limits. IBM is not responsible for any radio or television interference caused by using other than recommended cables and connectors or by unauthorized changes or modifications to this equipment. Unauthorized changes or modifications could void the user's authority to operate the equipment.

This device complies with Part 15 of the FCC Rules. Operation is subject to the following two conditions: (1) this device may not cause harmful interference, and (2) this device must accept any interference received, including interference that may cause undesired operation.

### **Industry Canada Compliance Statement**

This Class A digital apparatus meets all requirements of the Canadian Interference-Causing Equipment Regulations.

### **Avis de conformité aux normes d'Industrie Canada**

Cet appareil numérique de la classe A respecte toutes les exigences du Règlement sur le matériel brouilleur du Canada.

### **Japanese Voluntary Control Council For Interference (VCCI) Statement**

This equipment is in the 1st Class category (information equipment to be used in commercial and/or industrial areas) and conforms to the standards set by the Voluntary Control Council for Interference by Information Technology Equipment aimed at preventing radio interference in commercial and industrial areas.

Consequently, when used in a residential area or in an adjacent area thereto, radio interference may be caused to radios and TV receivers, and so on.

Read the instructions for correct handling.

### **Korean Communications Statement**

Please note that this device has been approved for business purpose with regard to electromagnetic interference. If you find this is not suitable for your use, you may exchange it for a non-business one.

### **New Zealand Radiocommunications (Radio) Regulations**

Attention: This is a Class A product. In a domestic environment this product may cause radio interference in which case the user may be required to take adequate measures.

---

## **Trademarks and Service Marks**

The following terms, denoted by an asterisk (\*), used in this publication, are trademarks or service marks of IBM Corporation in the United States or other countries:

APPN	NetView	TCP/IP
ESCON	Nways	Telnet
DCAF	RETAIN	VTAM
HPR		

---

## **Safety**

This product meets IBM Safety standards.

For more information, see the *Safety Information*, GA33-0400.

---

## About This Guide

This guide applies to the IBM 3745 Communication Controller Models A, the IBM 3746 Nways\* Multiprotocol Controller Model 900, and the Multiaccess Enclosure (MAE), feature code 3001.

The main operation of these products is described, with the following functions and processes included:

- Service processor.
- Maintenance and Operator Subsystem - Extended (MOSS-E).
- Network node processor (3746-900 NNP or 3746-900 IP).
- Multiaccess Enclosure (MAE).
- CCM and Telnet IP.

Basic service procedures are described along with the following:

- Turning on the power for the 3745 and the 3746 Model 900.
- Performing an initial microcode load (IML) of the MOSS, the 3745 scanners, and the 3746 Model 900 processors.
- Fallback and a switchback for Models 41A and 61A.
- Enabling and disabling channel adapters.

For advanced functions, see the *Advanced Operations Guide*, SA33-0097, or the MOSS-E on-line help.

---

## Conventions Used in this Guide

When used in this guide, the term:

<b>3745</b>	Refers to the IBM 3745 Models 17A, 21A, 31A, 41A, and 61A with 3746 Models A11, A12, L13, L14 , or L15 Expansion Units.
<b>3746-900</b>	Refers to the IBM 3746 Nways Multiprotocol Controller Model 900.
<b>3746-900 NN</b>	Refers to the function of the 3746-900, operating as an APPN/HPR network node.
<b>3746-900 IP</b>	Refers to the part of the 3746-900 that operates as an IP router.
<b>3746</b>	Refers to the 3746-900 and 3746-950 communication controllers.

---

## Who Should Use this Guide

- Non-specialized personnel carrying out daily routine operations.
- Non-IBM personnel configuring remote consoles connected to the service processor running the MOSS-E.
- Personnel responsible for installing and changing program configurations, for example:
  - Network personnel
  - System programmers
  - System service personnel
  - IBM trained service representatives.

The user should have an understanding of teleprocessing, modem operations, and APPN/HPR.

Teleprocessing specialists can access online information (help, guides, and other material) for information on the following:

- Maintenance and Operator Sub-System - Extended (MOSS-E).
- Controller Configuration and Management (CCM).
- APPN/HPR and IP Control Point functions.
- Multiaccess Enclosure (MAE) Management.
- DCAF<sup>1</sup>\* installation.
- TCP/IP\* environment.

Further publications are listed in the Appendix C, "Bibliographies" on page C-1.

---

## How this Guide is Organized

The guide consists of the following chapters and appendixes:

- Chapter 1, "General Information on 3745 and 3746 Controllers," gives an overview of 3745 and 3746 controllers, with specifics on controller panels, and additional pointers on problem-solving.
- Chapter 2, "Service Processor," explains the functions of the service processor and how to connect a service processor to a remote console.
- Chapter 3, "Maintenance and Operator Sub-System-Extended (MOSS-E)," explains how to open the MOSS-E and MOSS sessions for the 3745 and for the 3746-900.
- Chapter 4, "Working with Network Node Processor (NNP) Functions," explains how to access the APPN/HPR control point and IP router functions of the NNP via the MOSS-E.
- Chapter 5, "Working with Multiaccess Enclosure (MAE) Functions," explains how to run the MAE from the MOSS-E and display MAE hardware configurations.
- Chapter 6, "Telnet IP Resource Management in CCM and MOSS-E," contains information on using CCM and the MOSS-E for Telnet commands.
- Chapter 7, "3745 Power ON and IPL from Control Panel," provides information on automatic and manual power ON/OFF and IPL procedures for the 3745.
- Chapter 8, "3745 IPL from Service Processor," provides information on IPL, checking power supplies, and IPL messages.
- Chapter 9, "3745 Models 41A and 61A Fallback and Switchback," explains fallback and switchback for twin-standby and twin-backup modes.
- Chapter 10, "Enabling and Disabling Channel Adapters," describes how enable or disable 3745 and 3746-900 channel adapters.
- Chapter 11, "Basic Service Procedures," explains how to activate, deactivate, and perform an IML for the 3745 and 3746-900, and is designed as a reference to service procedures normally performed by service personnel.

---

<sup>1</sup> The DCAF program is contained in Tivoli Management Environment (TME) 10 Remote Control. For the purposes of this guide, DCAF is referred to instead of TME 10 Remote Control.

- Appendix A, “3745 Operator Control Panel,” describes the 3745 control panel and the hexadecimal codes that display on it.
- Appendix B, “3746 Operator Control Panel,” describes the 3746-900 control panel.
- Appendix C, “Bibliographies,” lists the available customer documentation related to the 3745 and 3746-900.

The following information is included at the back of this guide:

- A list of abbreviations used in this guide, on page X-1.
- A glossary of terms which may be unfamiliar, on page X-3.
- An index is provided on page X-7.

---

## What is New in this Guide

This revised edition provides information on the following:

- Multiaccess enclosure (MAE) management.
- Service processor customization.
- Licensed internal code information.
- CCM/Telnet user profiles management.

---

## Where to Find More Information?

- “Customer Documentation for the 3745 (Models 210, 310, 410, 610, 21A, 31A, 41A, and 61A), and 3746 (Model 900)” on page C-1.
- “Additional Customer Documentation for the 3745 Models 130, 150, 160, 170, and 17A” on page C-5.
- “Help Pull-Down Menu” on page 3-8.
- *Introducing Enterprise Systems Connection*, GA23-0386.
- *IBM 3746 APPN/HPR Implementation Guide*, SG24-2536.
- *IBM 3746 IP Implementation Guide*, SG24-4845.
- *SNA Network to APPN Network Migration Experience*, SG24-4656.
- Networking Softcopy Collection Kit, SK2T-6012.

## World Wide Web

You can access the latest news and information about IBM network products, customer service and support, and microcode upgrade via Internet at the Uniform Resource Locator (URL):

<http://www.networking.ibm.com>





---

# Chapter 1. General Information on 3745 and 3746 Controllers

---

## The IBM 3745 and 3746 Controllers Family

For more than two decades, IBM's advanced line of communication controllers (3705, 3720, 3725, 3745, and 3746) have proved an effective solution for rapid changes in network technology. In particular, the 3745s and, more recently, the 3746-900 and the 3746-950, have proved cost effective for network evolution and adaptability to new functions.

IBM communication controllers include the following:

- 3745 Models 130, 140, 150, 160, and 170<sup>1</sup>.
- 3745 Models 210, 310, 410, and 610<sup>1</sup>.
- 3745 Models 17A, 21A, 31A, 41A, and 61A (3745 Models A).
- 3746 Model 900 (3746-900).
- 3746 Model 950 (3746-950).

These communication controllers were originally designed for the attributes and advantages of SNA. Later innovations in the same line incorporated developments in APPN, HPR, and IP. The following illustrates the adaptability of these controllers to advances in networking technology:

- The 3746-950 can operate as an IP router and APPN/HPR Network Node (NN), independent from any 3745 running a Network Control Program (NCP).
- The 3746-900 supports the same routing functions as the 3746-950.
- The 3746-900 can operate as an IP router and APPN/HPR NN, and simultaneously operate as an NCP-controlled SNA subarea node or APPN composite network node (CNN).

The 3746 Models 900 and 950 form a new generation of controllers, the *3746 Nways Multiprotocol Controllers*. These controllers form the basis of efficient and reliable multiprotocol networks that support both SNA applications and TCP/IP applications.

By integrating the 3746-900 and the 3746-950 into your network, you can add the advantages of APPN/HPR and IP, and still support your existing SNA configurations. Figure 1-1 on page 1-2 illustrates the development of 3745 and 3746 controllers in line with the evolution of networking technologies.

---

<sup>1</sup> These models are no longer manufactured.

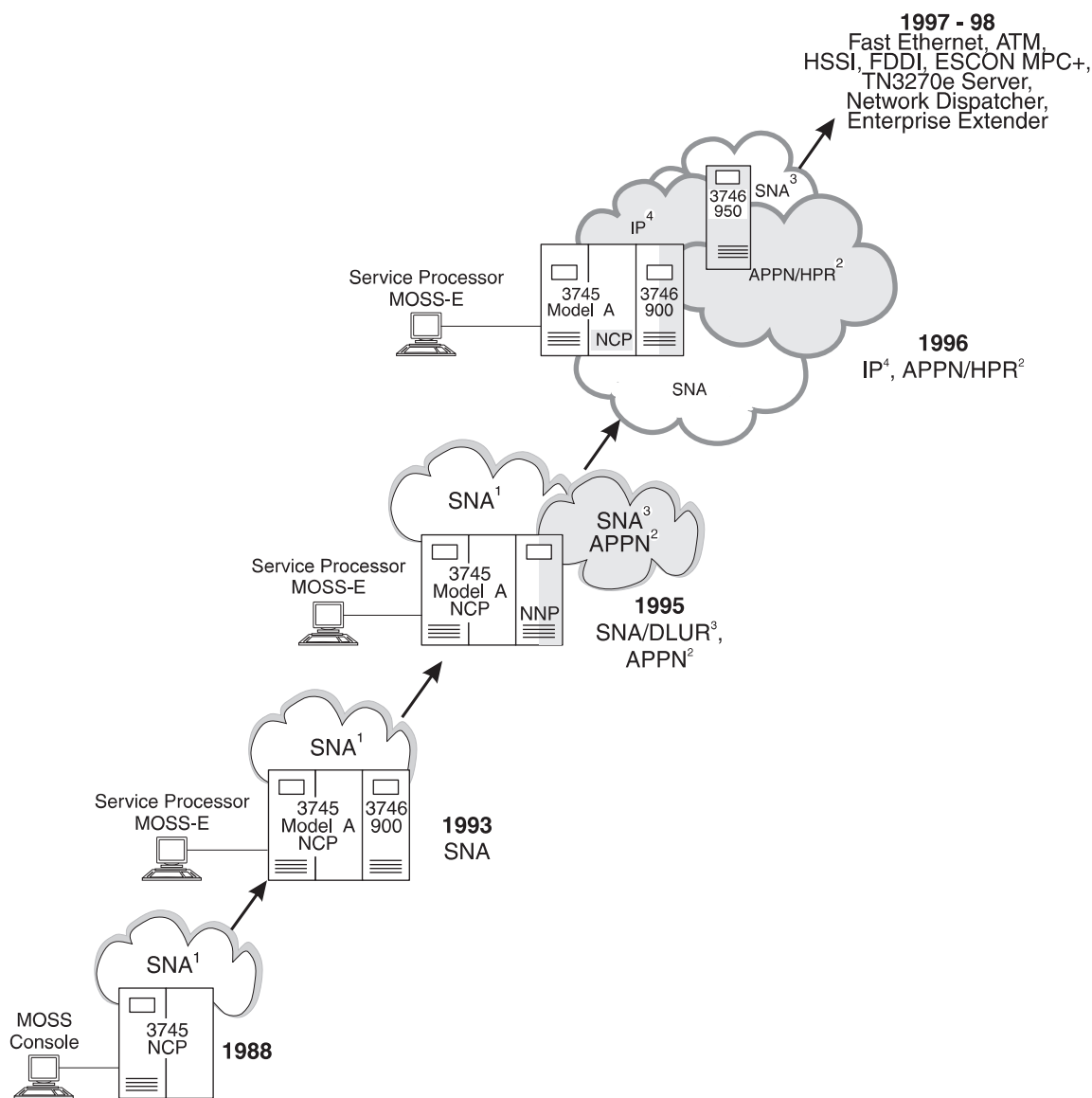

Figure 1-1. The Networking Evolution of IBM 3745 and 3746 Controllers

**Notes:**

1. This controller configuration supports SNA networking and the APPN CNN function along with NCP and VTAM.
2. APPN networking, using a network node processor (NNP), independent from NCP and VTAM.
3. Connectivity with SNA devices using the Dependent Logical Unit Requester support (DLUR), and a VTAM with Dependent LU Server (DLUS).
4. IP networking using the NNP and 3746 IP routing features, independent from NCP and TCP/IP MVS.

---

## Getting Started

To operate the 3745 and 3746, you will need the following:

- Service processor, color display, pointing device (usually a mouse), and keyboard.
- 3745 operator control panel. This is operational even when the 3745 is deactivated (see Chapter 11, “Basic Service Procedures” for a description of control panel displays, indicators and switches).
- The 3746 operator control panel. This is operational even when the 3746 is deactivated (see Chapter 11, “Basic Service Procedures” and Appendix B, “3746 Operator Control Panel” for a description of control panel displays, indicators and switches).

---

## Locating Processors

The service processor and network node processors are located in a controller expansion unit next to the 3746 or the 3745 Models A (see Figure 1-2).

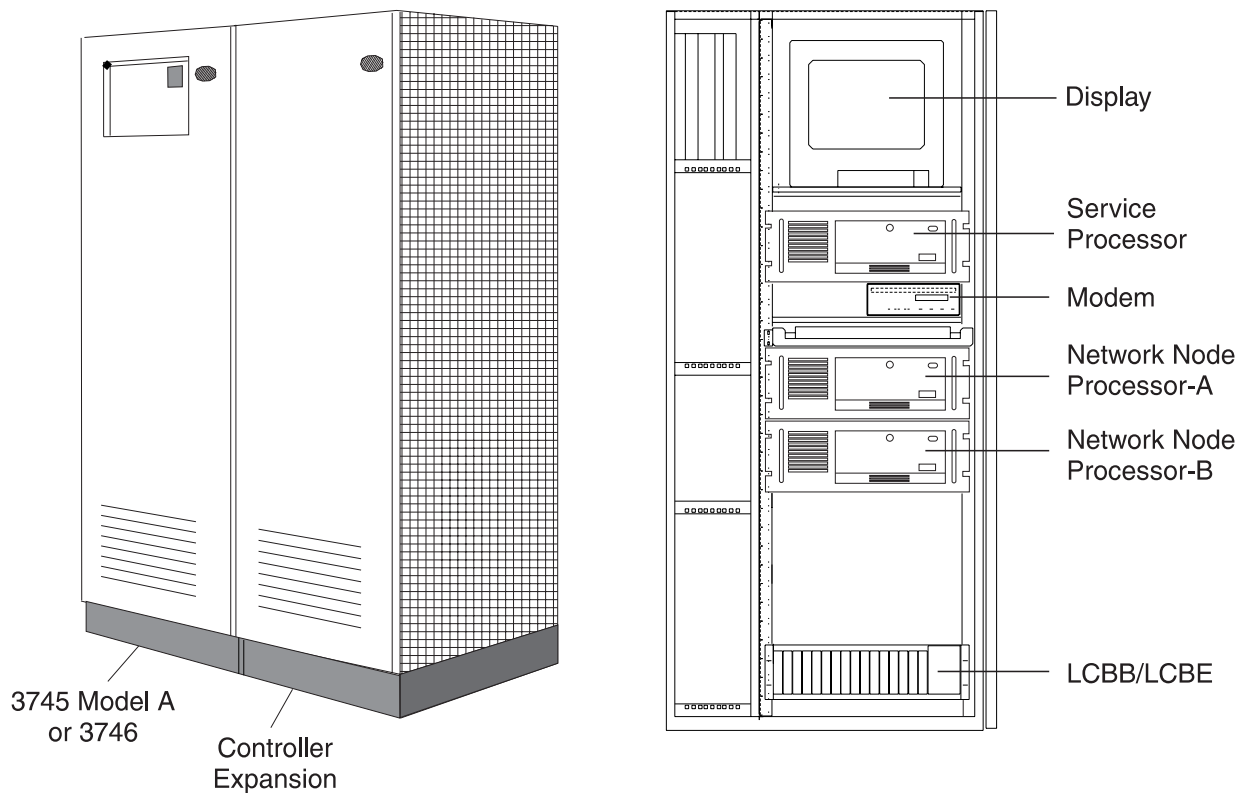

Figure 1-2. 3745 Model A or 3746 with Controller Expansion

## Control Panels

### Note

The same control panel numbers on both the 3745 and 3746 do not always indicate the same function.

### The 3745 Control Panel

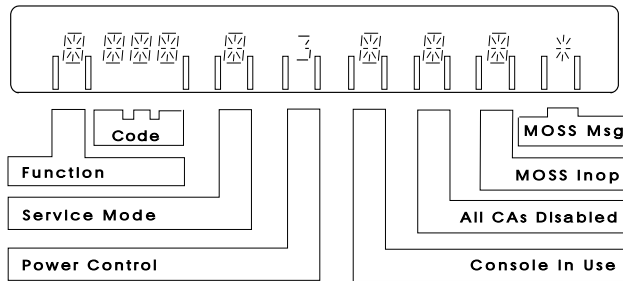

3745 control panel display. For more information on displays, see in Appendix A, "3745 Operator Control Panel" on page A-1.



Option 3 is selected.



Indicator is on.

### The 3746 Control Panel

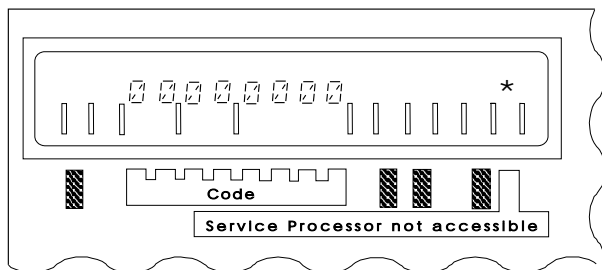

3746 control panel display. For more information on displays, see B-1.

## Stop Switch for the 3745

Located on the 3745 control panel (see Figure 1-3 on page 1-5).

### Attention

Even if the stop switch is in the OFF position, the primary power box is still connected to the electric current. To disconnect completely, do the following:

1. Turn off the main circuit breaker.
2. Remove the power plugs from supply outlets.

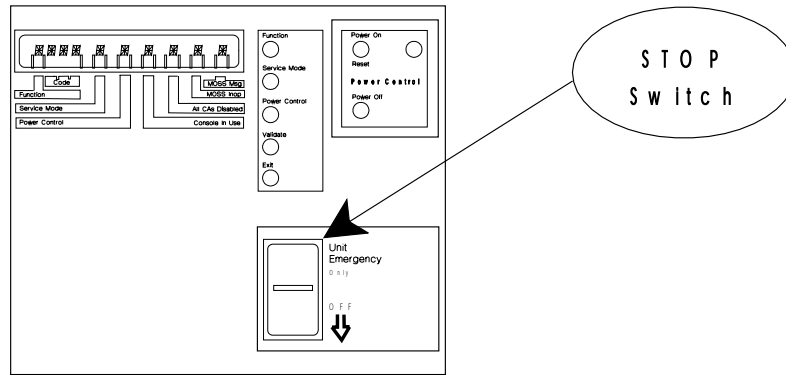

Figure 1-3. IBM 3745 Control Panel

The stop switch is meant only as a backup to the Power OFF button. If you use the stop switch to Power OFF, you will need an IBM service representative to restart the controller.

## Solving Problems

There are three levels of problem resolution. If you encounter a problem, start at the first level and work down:

### 1. First Level

Use online help to solve the problem. See "Help Pull-Down Menu" on page 3-8.

### 2. Second Level

Contact the person in charge of 3745/3746 problem analysis.

#### HELP CONTACT

Name: .....

Telephone: .....

### 3. Third Level

Forward a report to the IBM support center. Before you do this, try levels 1 and 2 first so that you will have as much information as possible for IBM support personnel.

## Alarms

Alarms in the 3745 or 3746 are indicated by a red bell icon . This appears in the **MOSS-E View**, next to the controller that produced the alarm.

If the MOSS-E window is an icon or hidden, it will automatically appear in front of any open windows, and display the red alarm bell. Double-click the  to open **Display Alarms** (see the online help for more information).

If you use IBM's remote support facility (RSF) when a problem is reported to RETAIN\* (either automatically or manually), two alarms are generated, one when the call is made to RSF, and a second when IBM answers the call.



---

## Chapter 2. Service Processor

---

### Using the Service Processor

The service processor connects the 3745 to the 3746, and provides a single user interface for 3745 and 3746 operator and service functions.

The service processor runs MOSS-E to perform the following:

- Maintenance and operator subsystem (MOSS) functions in the 3745. MOSS screens are the same for the operator consoles of the 3745 Models 130, 150, 160, 170, 210, 310, 410, and 610.
- Graphic status displays of the controllers connected to the service processor.
- Maintenance and operation of the 3745 Models A and the 3746-900.

The service processor also performs the following:

- Runs Controller Configuration and Management (CCM)<sup>1</sup> for the following:
  - Configuring the 3746 APPN/HPR Network Node and IP Router with ESCON Generation Assistant (EGA).
  - Displaying information about 3746 resources, for example, the current local network topology.
  - Managing multiple configurations of 3746 resources.
- Loads 3746 microcode.
- Stores information, for example, configuration data file-extended (CDF-E) files on 3746 hardware resources.
- Reports 3746 errors as alerts to NetView\* and sends error codes to the IBM Remote Support Facility (RSF). Error codes are locally stored by the service processor and can be displayed by the user.

The service processor normally runs unattended and should always be operational. However, normal network operations are not affected if the service processor is temporarily disabled.

### Connecting the Service Processor

The service processor communicates with the 3745 MOSS, the 3746, and the network node processor via a Service Processor Access Unit (SPAU). The SPAU can be shared with other 3745s and 3746s.

If a SPAU is connected to a 3746 network node or a 3746-950, it cannot be shared by other user stations, as it must be isolated from user traffic. Otherwise, DCAF consoles can be connected to the SPAU for remotely controlling the service processor or operating the 3746 network node and 3746 IP router. If remote console access runs via bridges, there must be appropriate LAN filtering to protect the SPAU segment. The SPAU is packaged with a service processor and provides a LAN connection between the service processor and equipment attached to controllers 3745, 3746-900, and 3746-950.

---

<sup>1</sup> CCM is also available in a stand-alone OS/2 version.

The 3745 includes specific MOSS hardware and microcode to support communications with the service processor.

## Sharing the Service Processor

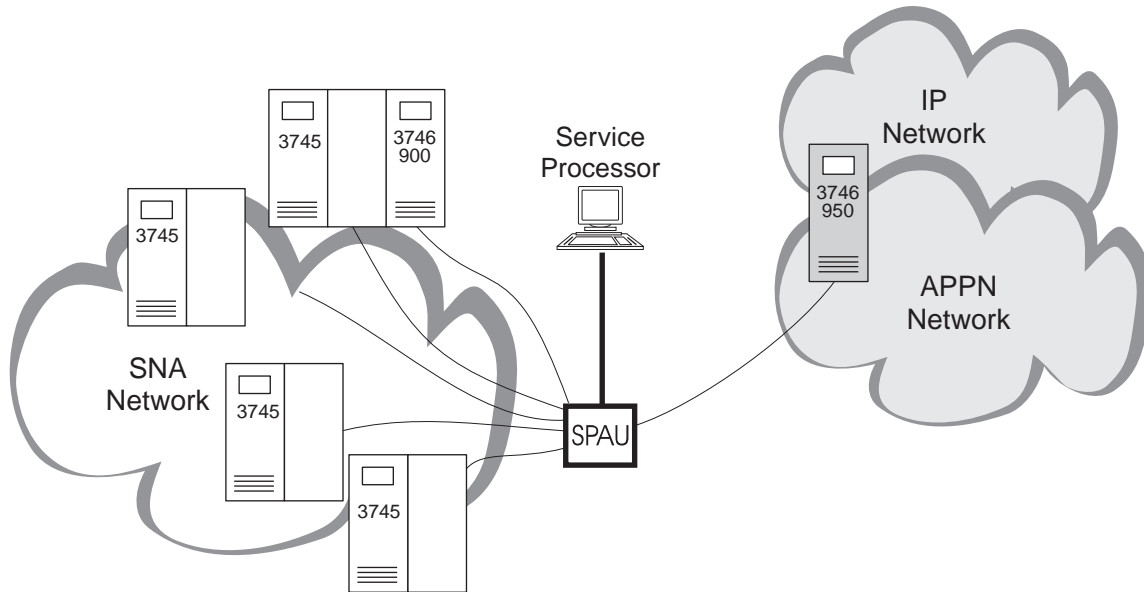

### Legend

SPAU Service Processor Access Unit

Figure 2-1. Example 1 of a Maximum Configuration. Service Processor running four 3745s, one 3746-900 (SNA), and one 3746-950 (IP, or APPN/HPR).

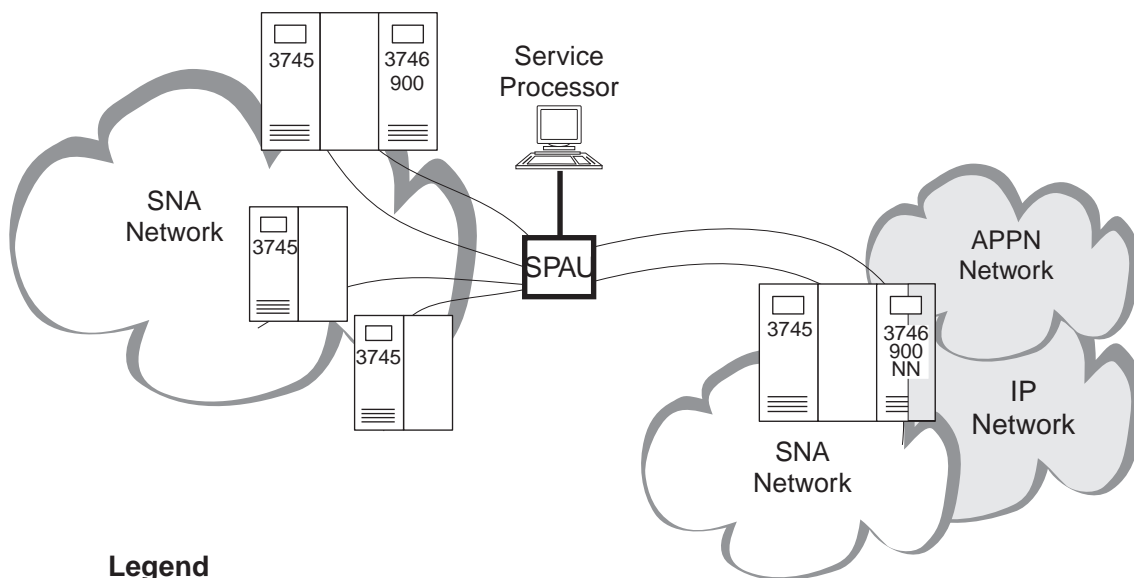

### Legend

SPAU Service Processor Access Unit

Figure 2-2. Example 2 of a Maximum Configuration. Service processor running four 3745s and two 3746-900s, one operating as an APPN/HPR network node.

A service processor can run the following controller and expansion unit combinations:



- Four 3745s and two 3746-900s operating in an SNA mode (controlled by NCP).
- Four 3745s, one 3746-900 operating in an SNA mode (controlled by NCP), and one 3746-950 (see Figure 2-1 on page 2-2).
- Four 3745s and two 3746-900s, one operating as an IP Router and APPN/HPR network node (see Figure 2-2 on page 2-2).

IBM recommends that controllers be installed in the room, within 10 m of the service processor. Connecting an additional controller to the service processor will not interfere with ones already installed.

Large installations that need more than four 3745s and two 3746-900s require several service processors and controllers. If all the groups are attached to the same token-ring LAN (either directly attached or through a token-ring bridge), then one remote DCAF console located at a central control point can access and control all the 3745s/3746s located in the same or different machine rooms.

---

## Using DCAF to Remotely Log On to the Service Processor

PS/2\* (or equivalent) workstations can remotely access the service processor MOSS-E and CCM functions through DCAF, an IBM licensed program. A DCAF session allows the user to either:

- Control a target service processor from a remote workstation keyboard and mouse.
- Monitor a target service processor in the DCAF window of a remote workstation.

DCAF enables the remote workstation to operate as a controlling workstation and the service processor to operate as a target workstation. When a DCAF session is established between a remote workstation and a service processor, the user of the remote workstation can perform MOSS-E functions as though seated before the service processor.

## Remote Consoles

There are five types of remote console. These types define how the console is connected to the service processor.

### LAN-attached

APPC type consoles that attach either:

- Directly to the same token-ring LAN as the service processor.
- Indirectly through token-ring LAN bridges.

### LAN-attached

TCP/IP type consoles that attach to the Service Processor Access Unit (SPAU) via a bridge with filtering.

### SNA-attached

Consoles that communicate with a service processor via an LU6.2 session on a backbone.

### APPN-attached

Consoles that communicate with the service processor via an LU6.2 session on a backbone.

### **Modem-attached**

Consoles using a public switched telephone network to access a service processor via its SDLC port and modem.

A remote console can be configured for many different types of network access. For example, a single console at a central control site LAN-attached to a local service processor, can also provide APPN and modem access to remote service processors.

For more information, see *Console Setup Guide*, SA33-0158 or the *DCAF: Installation and Configuration Guide*, SH19-4068.

---

## **Backing Up the Service Processor**

Backing up the service processor requires the following:

- Setting up a backup service processor.
- Saving the following configuration data:
  - Active MOSS-E to the backup hard disk
  - Active MOSS-E microcode to the backup hard disk.

## **Setting Up a Backup Service Processor**

Before you set up a backup service processor, check that the microcode levels are the same for both the backup and the primary service processor.

If the microcode levels are not the same, use one of the following methods to set the same level in both:

- Install the microcode of the active service processor onto the hard drive of the backup service processor (see “Installing Microcode to a Backup Service Processor” on page 2-6).
- Copy the active configuration onto the hard disk of the backup service processor (see “Backing Up Configurations to a Backup Service Processor”).

Follow the procedure below to check the microcode levels of the primary and backup service processor:

### **Procedure for Displaying EC level D46130x ECA 167 and Above**

**Step 1.** Log on to the MOSS-E (see “Logging On to MOSS-E” on page 3-4).

**Step 2.** Click **Help**.

**Step 3.** Click **About**.

**Step 4.** Click **Licensed Internal Code**.

**Step 5.** Compare the two microcode levels.

## **Backing Up Configurations to a Backup Service Processor**

When configuration data is updated on the active service processor, you must save it on to backup diskettes (see “Backing up Controller Configurations” on page 3-18). This process takes about five minutes.

### Service Processors with CD-ROM

This procedure applies to service processors with a CD-ROM drive, feature code 5052. Previous versions of service processors included an Optical Disk for saving and backing up configurations.

Save new configuration data by copying it onto the hard disk of the backup service processor as follows:

- Step 1.** Power ON the backup service processor. This produces an error message because the backup service processor is not connected to the LAN. Cancel this message by clicking **OK**.
- Step 2.** Log on to the backup service processor (see “Logging On to MOSS-E” on page 3-4).
- Step 3.** Open the **Service Processor** menu.
- Step 4.** Click **Operation Management**.

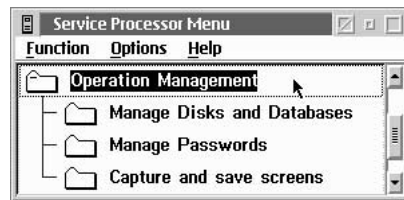

- Step 5.** Click **Manage Disks and Databases**.

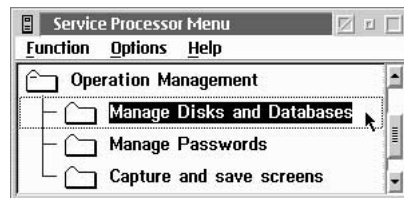

**Step 6.** Select **Restore databases from diskettes(s)**.

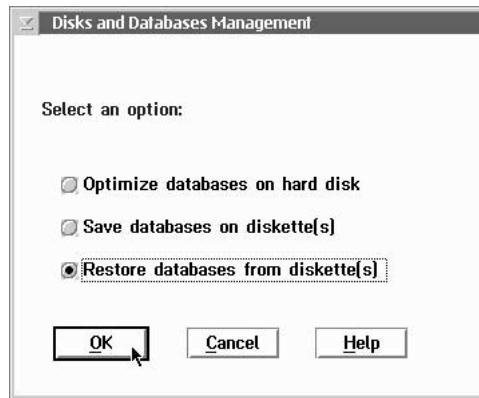

**Step 7.** When you have finished, power OFF the backup service processor.

At power ON, the backup service processor automatically registers the new configuration data.

## Installing Microcode to a Backup Service Processor

Use the following procedure to install microcode onto a backup service processor.

**Step 1.** Power ON the backup service processor. This produces an error message because the backup service processor is not connected to the LAN. Cancel this message by clicking **OK**.

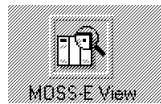

**Step 2.** Double-click the **MOSS-E View** icon.

**Step 3.** Type in a password and click **OK**.



**Step 4.** In **MOSS-E View**, open the service processor machine menu.

**Step 5.** Click on **Change Management**.

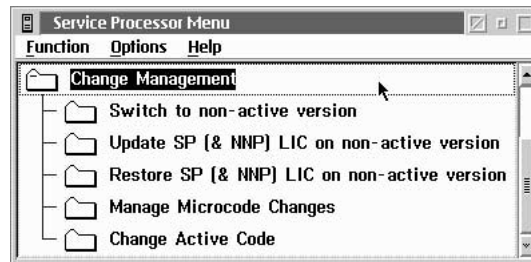

**Step 6.** Insert the CD with the service processor installation code into the CD-ROM.

**Step 7.** Double-click **Restore SP (&NNP) LIC on non-active version**.

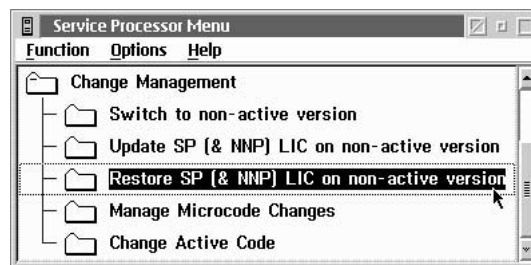

**Step 8.** Follow the prompts.

## Installing a Backup Service Processor

If the active service processor fails, replace it with the backup service processor as follows:

### Attention

Make sure the microcode and configuration levels are the same in both the primary and the backup service processor.

**Step 1.** Power OFF the active service processor.

**Step 2.** Verify that the backup service processor is powered OFF.

**Step 3.** Disconnect the active (failed) service processor from the token-ring LAN.

**Step 4.** If necessary, disconnect any RSF modem or telephone lines.

**Step 5.** Connect the backup service processor to the token-ring LAN.

**Step 6.** If necessary, connect the backup service processor to any RSF modem or telephone lines.

**Step 7.** Check that the service processor installation diskette is not in the backup service processor disk drive.

**Step 8.** Power ON the backup service processor.



## Chapter 3. Maintenance and Operator Sub-System-Extended (MOSS-E)

### Beginners should read this...

The following procedures assume that you know how to operate a mouse in a windows environment.

Before you begin, make sure that the service processor is on and that **MOSS-E View** is displayed.

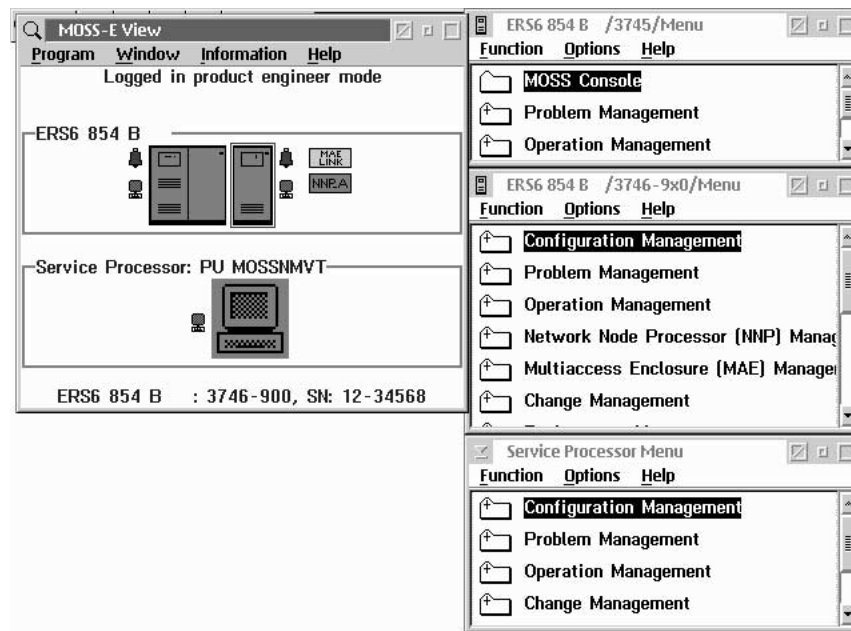



Figure 3-1. MOSS-E View Window with Machine Menus

The basic **MOSS-E View** window (left in Figure 3-1) provides access to other windows and functions. The figure above shows a minimum configuration, with two areas:

- For 3745 Model A, 3746, and network node processors.
- For service processors.

Double-click the machine icon to open a menu with associated tasks (this does not apply to the network node processor). A  next to each machine icon indicates an open machine menu (see the right side of Figure 3-1).

The contents of the menu depends on the logon mode that you used (see “Logging On to MOSS-E” on page 3-4).

Select an object and click the right mouse button to display a pull-down menu.

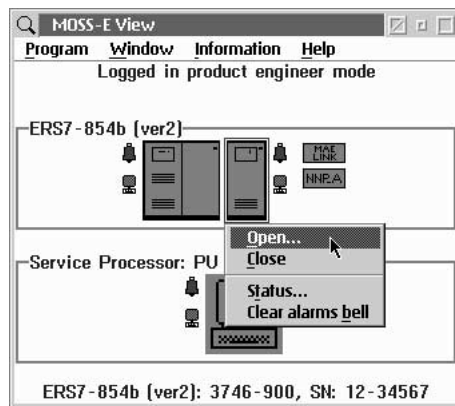

From a pull-down menu, you can do the following:

- Open a machine menu.
- Close a machine menu.
- Display the status of a machine (this does not apply to the service processor).
- Clear alarm bells.

---

## MOSS-E Passwords

When logging on to the MOSS-E through the **MOSS-E View** window, choose the password that corresponds to the mode and functions that you want to use.

There are four password modes for secure access to customer and maintenance functions of MOSS-E menus.

### **Controller customer password**

Access to operator functions in the 3746 and 3745 menus. For first level operators.

### **Controller maintenance password**

Access to operator and maintenance functions in the 3746 and 3745 menus. For IBM Service personnel.

### **Service processor customer password**

Access to operator functions in the service processor and controllers. For supervisors and system programmers.

### **Service processor maintenance password**

Access to functions in the service processor and controllers. Take care in distributing this password because IBM requires it for service procedures.

**Note:** Use 5 to 8 alphanumeric characters for passwords. Each mode must have a password unique from passwords in the other modes.



## Changing Passwords

To change a password:

- Step 1.** Open the **Service Processor** menu.
- Step 2.** Select **Operation Management**.
- Step 3.** Select **Manage Passwords**. Enter the management password (the default is **IBM3745**) and click **OK**.
- Step 4.** Click **MOSS-E view passwords** and click **OK**.

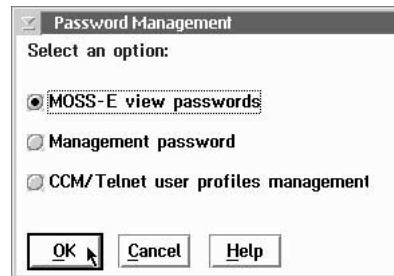

- Step 5.** Re-enter new passwords and click **Apply**.

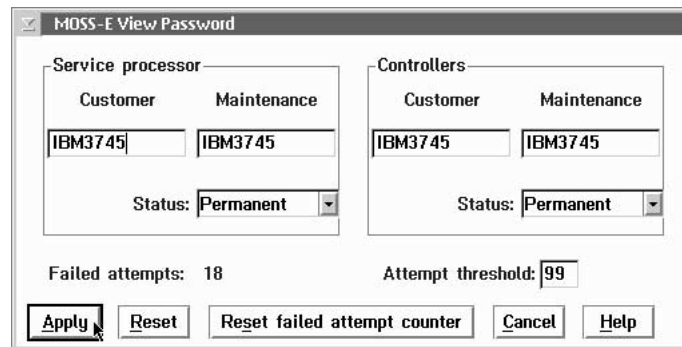

- Step 6.** Click **Management password** and click **OK**.
- Step 7.** Enter the new management password and click **Apply**.

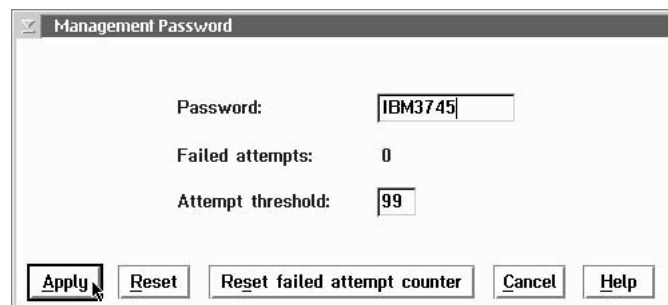

- Step 8.** Click **CCM/Telnet user profiles management** if you want to use CCM functions for Telnet access and IP resource management. For more information, see Chapter 6, "Telnet IP Resource Management in CCM and MOSS-E" on page 6-1.

**Step 9.** Enter a **Userid** and **Password** and click **OK**.

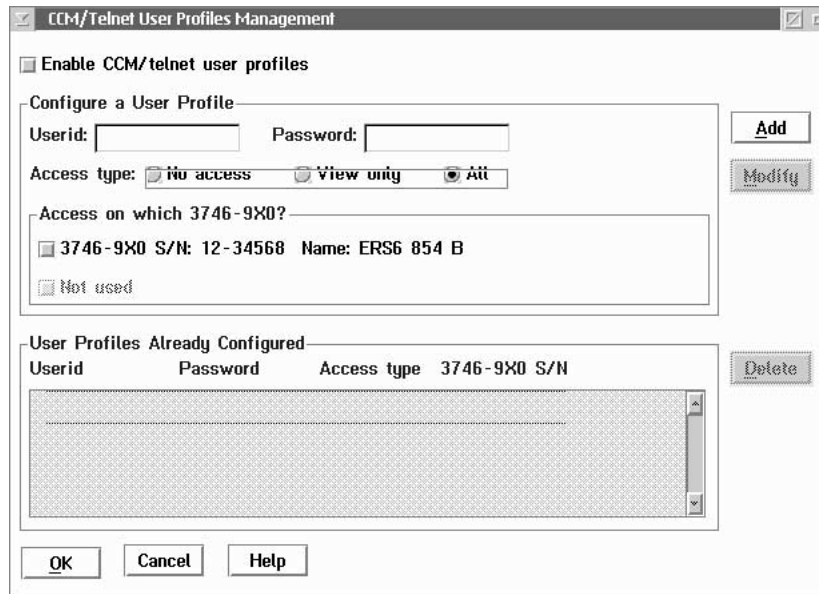

**Step 10.** Click **Cancel** to exit.

## Logging On to MOSS-E

**Step 1.** If the **MOSS-E View** window displays, go to Step 3 on page 3-5. Otherwise continue with next step.

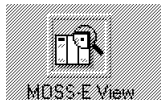

**Step 2.** Double-click the **MOSS-E View** icon. If **MOSS-E View** does not display, either:

- Press **Ctrl** and **Esc** for the **Window List** and double-click **MOSS-E View**.



- See “Problems with MOSS-E or the Service Processor” on page 3-9.

**Step 3.** Click **Program**, then **Log on MOSS-E**.



**Step 4.** Type in a password that corresponds to a logon mode and click **OK**.



**Step 5.** If the logon is successful, a message at the top of the MOSS-E View window shows the mode that you have logged into.

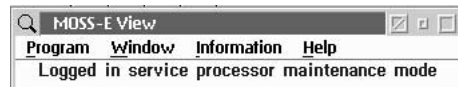

If there are problems with logging on, see one of the following:

- “Help Pull-Down Menu” on page 3-8.
- “Problems with MOSS-E or the Service Processor” on page 3-9.

Otherwise, contact the person in charge of 3745 and 3746 problem analysis (see “Solving Problems” on page 1-5).

**Step 6.** MOSS-E menus and functions are now available (see page 3-8).

## Logging Off the MOSS-E

**Step 1.** Click **Program** in the **MOSS-E View** window and click **Log off MOSS-E**. Then click **OK**. A logoff is successful message displays.

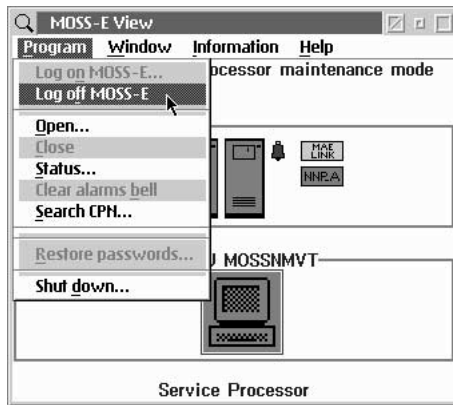

**Step 2.** A message at the bottom of the **MOSS-E View** window indicates that you can logon if you want.

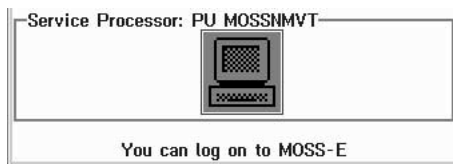

---

## Program Pull-Down Menu

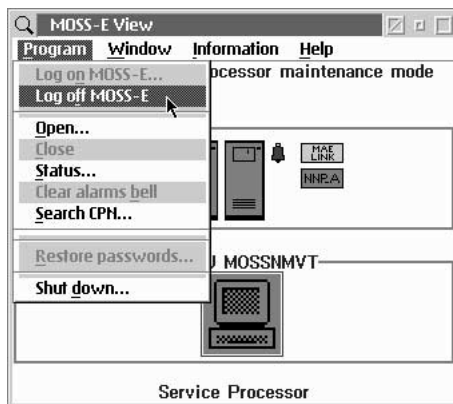

As well as logging on or off, this menu provides the following selections:

- Open**                      Opens menus for 3745, 3746, and service processor.
- Close**                     Closes a menu.
- Status**                    Displays information on 3745 or 3746.
- Clear alarms bell**      Clears alarms with a pending status.

- Search CPN** For controller maintenance by a customer engineer.
- Restore Passwords** For restoring default passwords (**IBM3745** in capital letters).
- Shutdown** Exits all programs and shuts down, with a message prompt to turn off or restart the system.

## Window Pull-Down Menu

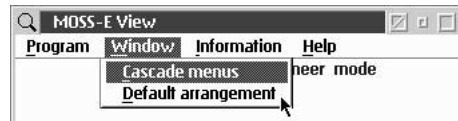

- Cascade menus** Arranges the menus that you have open in a stacked formation, like index cards.
- Default arrangement** Restores your own arrangement.

## Information Pull-Down Menu

**Note:** You can work with the **Information menu** without being logged on.

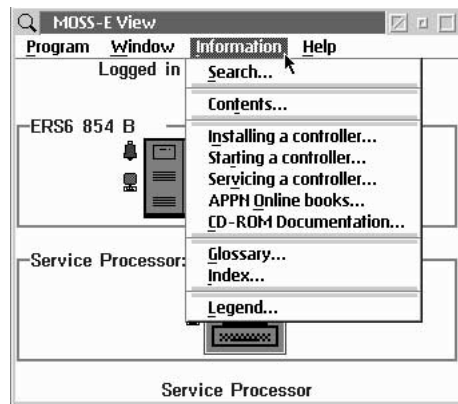

For detailed information on the 3745, 3746, and service processor.

- Search** Searches for information on an entry that you make in a text box.
- Contents** Lists the main tasks related to the communication controller.
- Installing a controller** Information on installing a controller.
- Starting a controller** Information on starting a controller.
- Servicing a controller** Information on servicing a controller.
- APPN Online books** Information that can be accessed directly from the service processor, for example, *Problem Analysis Guide*.
- CD-ROM Documentation** A listing of books available on CD-ROM.
- Glossary** Abbreviations and definitions about the 3745 and 3746 with any diagrams of main components.

<b>Index</b>	An alphabetical list of subjects related to the 3745 and 3746 and any main components.
<b>Legend</b>	A list of colors for machine objects in the <b>MOSS-E View</b> window. Each color indicates the status or condition of the machine.

---

## Help Pull-Down Menu

**Note:** You can access the **Help** menu without being logged on.

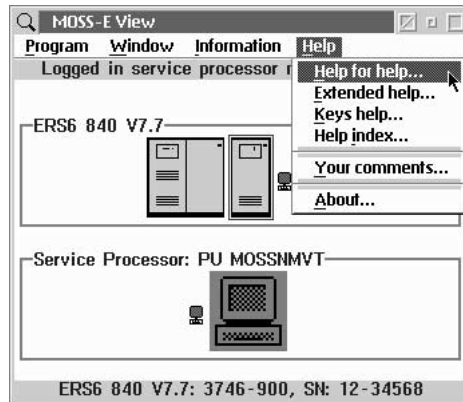

<b>Help for help</b>	Explains how to use Help.
<b>Extended help</b>	Information about the functions of the <b>MOSS-E View</b> window.
<b>Keys help</b>	Lists the function keys of the MOSS-E.
<b>Help index</b>	Lists Help items in alphabetical order.
<b>Your comments</b>	Information on where to send your reader's comments on MOSS-E information and usability.
<b>About</b>	Information on MOSS-E copyright and Licensed Internal Code.

---

## MOSS-E Menus, Tasks, and Functions

MOSS-E menus are the link between you and MOSS-E functions. There is a MOSS-E menu for the 3745, 3746, and also for the service processor as well.

### How to Use a Machine Menu

To display the menu for a machine, you must be logged on to the MOSS-E (see "Logging On to MOSS-E" on page 3-4). After logging on, double-click a machine object to open a menu with a task list (see the following **Service Processor** menu).

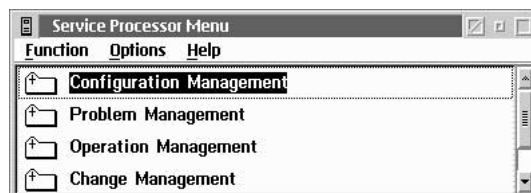

Clicking a task will displays a list of functions. Clicking an open menu closes it.

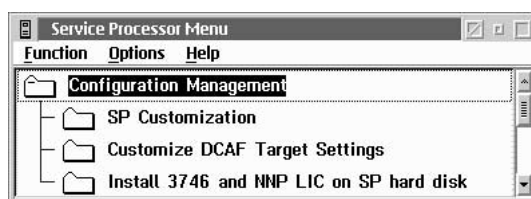

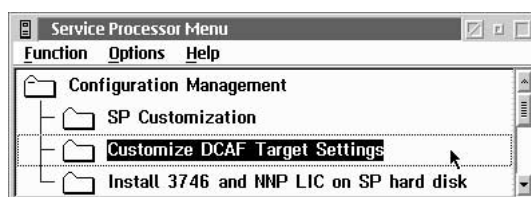

Double-clicking a function runs it. This is indicated by the color change of the function when it runs.



---

## Problems with MOSS-E or the Service Processor

If the keyboard and mouse are not responding to input, the service processor may be under the control of a DCAF remote console. To regain control of the service processor, press the DCAF hotkeys   together.

The following problems may occur:

- Service processor screen is dark.
- Service processor screen does not contain a **MOSS-E View** window or icon (see Figure 3-1).
- OS/2 or Communication Manager error message displays.

If any of the above occurs, IPL the service processor as follows:



### Attention

Performing an IPL disrupts traffic. Before performing an IPL, ask the network administrator to stop traffic, or wait until the next maintenance window is available.

If your service processor is powered OFF, go to Step 1. Otherwise, go to Step 2.

**Step 1.** Turn on your service processor. Wait until the first **MOSS-E View** displays.

**Step 2.** IPL your service processor by doing the following:

- Press   . Wait until the **MOSS-E View** displays.
- Turn off the service processor, wait a few seconds and turn it on again. Wait until the **MOSS-E View** displays.

If this does not work, contact the person in charge of 3745 or 3746 problem analysis (see “Solving Problems” on page 1-5 and “Help Pull-Down Menu” on page 3-8).

---

## MOSS Window

A MOSS window is a link between you and the MOSS running in the 3745. There is one window for each 3745 attached to the service processor.

This section provides information on the following:

- MOSS screens
- Using certain keys
- Opening a MOSS window
- Accessing MOSS functions.

## How to Open the MOSS Window

After you log on to the MOSS-E (see page 3-4), follow the steps below:

**Step 1.** Double-click the 3745 in the **MOSS-E View** to display the menu.

**Step 2.** Double-click **MOSS Console**.

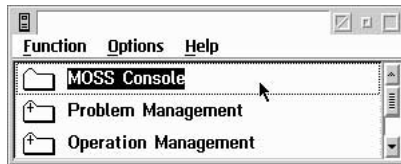

Opening a MOSS-E window for the first time displays the **FUNCTION SELECTION RULES** screen (see Figure 3-3 on page 3-13).

You can review the status of a machine in the **MOSS-E View** window by clicking **Information**, then **Legend**.

If you have problems logging on the MOSS-E, see the following:

- “Help Pull-Down Menu” on page 3-8.
- “Problems with MOSS-E or the Service Processor” on page 3-9.

If you still have a problem, contact the person in charge of 3745 and 3746 problem analysis. See “Solving Problems” on page 1-5.

## Service Processor MOSS Screen Layout

See the following for an example of a service processor MOSS screen.







This key moves the cursor from one input area to another.

## Common Commands and Function Keys

**OFF**

Enter **OFF** to logoff and close the MOSS window. If a function is active or pending, press  first.



Closes any active functions. Menu 1 or Menu 2 displays, depending on the function that you close.



Displays menu 1, menu 2, or a pending function.



Displays the **Function Selection Rules** screen.

## Selecting MOSS Functions

When you open a MOSS window, the **Function Selection Rules** screen displays.

More information on the **Function Selection Rules** screen is shown in the *Advanced Operations Guide*.

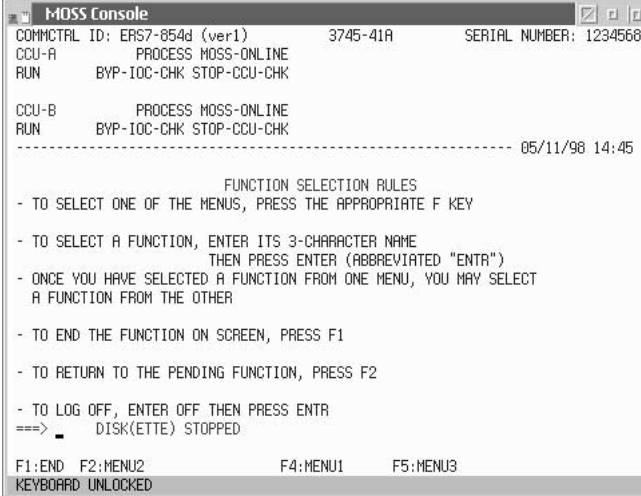

```
MOSS Console
COMMCTRL ID: ERS7-854d (ver1)      3745-41A      SERIAL NUMBER: 1234568
CCU-A      PROCESS MOSS-ONLINE
RUN      BYP-IOC-CHK STOP-CCU-CHK

CCU-B      PROCESS MOSS-ONLINE
RUN      BYP-IOC-CHK STOP-CCU-CHK

----- 05/11/98 14:45

FUNCTION SELECTION RULES
- TO SELECT ONE OF THE MENUS, PRESS THE APPROPRIATE F KEY

- TO SELECT A FUNCTION, ENTER ITS 3-CHARACTER NAME
  THEN PRESS ENTER (ABBREVIATED "ENTR")
- ONCE YOU HAVE SELECTED A FUNCTION FROM ONE MENU, YOU MAY SELECT
  A FUNCTION FROM THE OTHER

- TO END THE FUNCTION ON SCREEN, PRESS F1

- TO RETURN TO THE PENDING FUNCTION, PRESS F2

- TO LOG OFF, ENTER OFF THEN PRESS ENTR
===>  _  DISK(ETTE) STOPPED

F1:END  F2:MENU2      F4:MENU1  F5:MENU3
KEYBOARD UNLOCKED
```

Figure 3-3. Function Selection Rules Screen

The following keys are available:



Ends a function.



Displays Menu 2 functions (see "Menu 1 and 2 Functions" on page 3-14).



Displays Menu 1 functions (see "Menu 1 and 2 Functions" on page 3-14).

You can also enter the three-letter codes of MOSS function on the command line. For more information, see the next section "Menu 1 and 2 Functions" on page 3-14).

## Menu 1 and 2 Functions

**Note:** Depending on the model of your 3745, some of the functions shown below may not be available.

```

MOSS Console
COMMCTRL ID: ERS7-854d (ver1)      3745-41A      SERIAL NUMBER: 1234568
CCU-A      PROCESS MOSS-ONLINE
RUN      BYP-IOC-CHK STOP-CCU-CHK

CCU-B      PROCESS MOSS-ONLINE
RUN      BYP-IOC-CHK STOP-CCU-CHK

----- 05/11/98 14:46

                MENU 1

CONFIG DATA FILE.: CDF      IML ONE SCANNER...: IMS      PORT SWAP FILE...: PSF
CONTROL PGM PROC.: CPP      IPL CCU(S).....: IPL      POWER SERVICES...: POS
DISK FUNCTIONS...: DIF      LD LINK TEST REQ.: LTQ      SCANNER I/F TRACE: SIT
DISK IPL INFO...: DII      LD LINK TEST RESP: LTS      STAND ALONE TEST.: SAT
EVENT LOG DISPLAY: ELD      LINE INTERF DSPLY: LID      TIME SERVICES...: TIM
FALLBACK.....: FBK      LINK IPL PORTS...: LKP      SWITCHBACK.....: SBK
IML MOSS.....: IML      MACHINE LVL TABLE: MLT      TRSS INTERF DSPLY: TID
                MICROCODE FIXES...: MCF      WRAP TEST.....: WTT
                ESS INTERF DSPLY.: EID

                ENTER OFF TO LOG OFF
==> _  DISK(ETTE) STOPPED

F1:END  F2:MENU2                F5:MENU3  F6:RULES
KEYBOARD UNLOCKED
  
```

Figure 3-4. Menu 1 Functions

```

MOSS Console
COMMCTRL ID: ERS7-854d (ver1)      3745-41A      SERIAL NUMBER: 1234568
CCU-A      PROCESS MOSS-ONLINE
RUN      BYP-IOC-CHK STOP-CCU-CHK

CCU-B      PROCESS MOSS-ONLINE
RUN      BYP-IOC-CHK STOP-CCU-CHK

----- 05/11/98 14:47

                MENU 2

AC/BT PARAMETERS.: ABP      DISPLAY LONG.....: DLO      RESET IOC(S).....: RIO
BYPASS CCU CHECK.: BCK      MOSS OFFLINE.....: MOF      RESET I-STEP.....: RIS
BYPASS IOC CHECK.: BIK      MOSS ONLINE.....: MON      SET ADDR COMPARE.: SAC
CR INTERF DISPLAY: CID      REPAIRED CCU.....: REP      SET BRANCH TRACE.: SBT
CCU LV3 INTERRUPT: IL3      RESET ADDR COMP.: RAC      SET I-STEP.....: SIP
CCU NORMAL MODE...: CNM      RESET BRCH TRACE.: ABT      START CCU.....: STR
CCU SEL/RELEASE...: CSR      RESET CCU.....: RST      STOP CCU.....: STP
CCU STATUS.....: CST      RESET CCU CHECK...: RCK      STOP ON CCU CHECK: SCK
DATA EXCHANGE....: DEX      RESET CCU/LSSD...: ACL      STOP ON IOC CHECK: SIK
DISPLAY/ALTER....: DAL

                ENTER OFF TO LOG OFF
==> _  DISK(ETTE) STOPPED

F1:END  F2:MENU1                F5:MENU3  F6:RULES
KEYBOARD UNLOCKED
  
```

Figure 3-5. Menu 2 Functions



Enter the three letter code of a function on the command line and press .

**Note:** For Models 41A and 61A, enter CSR (CCU Selection and Release) on the command line to select a CCU. The selected CCU appears in the machine status area.

If a function is unavailable, the following message displays on the command line:

PRESS ENTER TO DISPLAY FUNCTION MENU

## Switching between Menu 1 and Menu 2 Functions

Use the  key to switch between menu 1 and menu 2. If you see  on the bottom part of the screen, this indicates that you can switch from one menu to the other.

You can enter the three letter code of a function from either menu on the command line at any time.

### Switching from a Menu 1 Function to a Menu 2 Function

**Step 1.** Press  to switch from menu 1 to Menu 2.

**Step 2.** Enter the code letters of a function and press .

#### Notes:

If you press , any menu 2 functions that are running will be suspended, and any menu 1 functions that are suspended will be re-activated.

Once any active functions of menu 1 have ended, any pending menu 2 functions will be re-activated.

### Switching from a Menu 2 Function to a Menu 1 Function

**Step 1.** Press  to switch from menu 2 to Menu 1.

**Step 2.** Enter the code letters of a function and press .



#### Notes:

If you press , any menu 2 functions that are running will be suspended, and any menu 1 functions that are suspended will be re-activated.

Once any active functions of menu 1 have ended, any pending menu 2 functions will be re-activated.

## How to Start and Stop Refresh

Press **F5** to refresh the information in a function area.

If you start a refresh and want to stop it, press   together.

## How to Close MOSS

You can close MOSS by doing one of the following:

- Double click the system menu icon in the upper left corner of the MOSS window.
- Enter OFF on the command line.

If you have problems closing MOSS, refer to the online help.

If you have technical problems, contact the person in charge of 3745 problem analysis (see page 1-5).

---

## Updating the Active CDF-E

Use the procedure below to record any new hardware as part of the controller hardware configuration, for example, lines connected to a LIC11.

This procedure ensures that the following information is recorded:

- Hardware character strings
- New CDF-E configuration saved as the working CDF-E
- Backup CDF-E copied on to diskette.

**Step 1** Double-click a 3746 object icon, or select a 3746 menu in the window list (see Step 2 on page 3-4).

**Step 2** Click **Configuration Management**, then double-click **Display/Update Active Configuration (CDF-E)**.

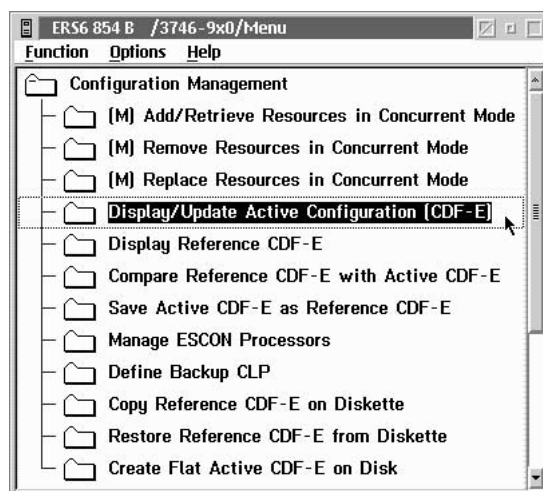

**Step 3** New or changed LCBs and ARCs for each CLP are shown in the **Resource Locator** screen (see the notes for Figure 3-6).

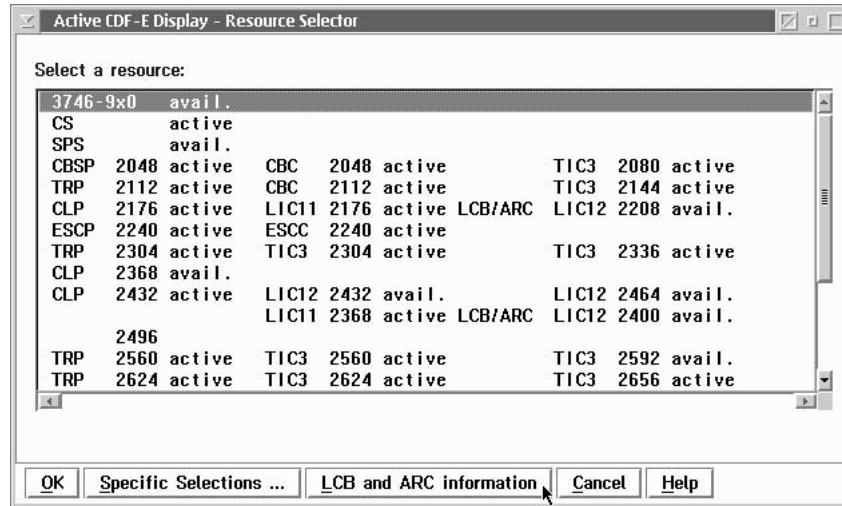

Figure 3-6. Resource Locator screen

**Notes:**

- A new LCB with an ARC is indicated by **LCB/ARC** to the right of the associated LIC11.
- A new LCB is indicated by **LCBB** to the right of the associated LIC11.
- A new LCBE will not display without an ARC installed in it, or until an IML procedure has been performed for the LCBE adapter.

**Step 4** Click **LCB and ARC information**.

**Step 5** Select the **LCBB** line, or for an LCBE, select the line just below the associated LCB.

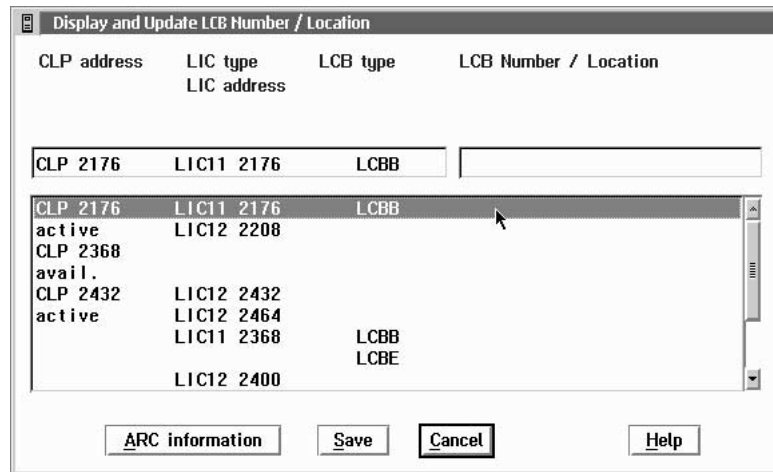

**Step 6** Enter or update the **LCB Number / Location** field. You can use up to 25 alphanumeric characters to identify an LCB attached to a processor. Existing codes should already be recorded in the *Planning Guide*, GA33-0457.

- Step 7** Press **Enter** and repeat steps 5 and 6 to identify more LCBs if you need to. Then click **Save** and **OK**.
- Step 8** If you have ARCs attached to a selected LCB, click **ARC information**. Otherwise, go to step 12.
- Step 9** Select an ARC, and enter or update the **Symbolic line name** field. You can use up to 8 alphanumeric characters to identify the ARC. Existing codes should already be recorded in the *Planning Guide*.

Display and Update ARC Symbolic Line Name

LCB range address: 2176-2190

LCB Number / Location: [ ]

ARC type	Line address	Position	Symbolic line name
ARC3A2	2176	+ 0	
		+ 1	
		+ 2	
ARC1B	2179	+ 3	
ARC1A2	2180	+ 4	
ARC1B	2181	+ 5	
ARC1B	2182	+ 6	
		+ 7	
ARC4B	2184	+ 8	
ARC1D	2185	+ 9	
ARC1B	2186	+ 10	
ARC1D	2187	+ 11	
		+ 12	
ARC1A2	2189	+ 13	
ARC1B	2190	+ 14	

Save Cancel Help

- Step 10** Press **Enter** and repeat steps 5 to 11 if you want to identify more ARCs. Then click **Save** and **OK**.
- Step 11** To identify ARCs on other LCBs, repeat step 9 and step 11 for each LCB.
- Step 12** When you have finished with all the LCBs and ARCs, click **Cancel**.
- Step 13** Double-click **Save Active CDF-E as Reference CDF-E**. Then click **OK**.

**Note:** It is recommended that you save the CDF-E onto diskette. For more information, see “Backing up Controller Configurations.”

## Backing up Controller Configurations

It is recommended that you backup the MOSS-E current controller configurations to diskette if you have done any of the following:

- Updated the CDF-E
- Customized DCAF target settings
- Managed passwords
- Configured remote operations
- Set automatic microcode download
- Updated CCM configurations.

Follow the steps below for backing up the controller configuration:

- Step 1.** Insert the backup diskette into the drive.



- Step 2.** Double-click the service processor object icon, or open the service processor menu in the window list (see step 2 on page 3-4).
- Step 3.** Click **Operation Management**.
- Step 4.** Double-click **Manage Disks and Databases**.



- Step 5.** Click **Save Databases on diskette(s)**.



- Step 6.** Click **OK**.
- Step 7.** Follow the prompts to save the active CDF-E onto the hard disk, and then onto diskettes.
- Step 8.** Click **Cancel** to exit.

**Note:** This procedure takes about 5 minutes and does not interfere with the operation of the service processor.



---

## Chapter 4. Working with Network Node Processor (NNP) Functions

Unless otherwise noted, this chapter applies to APPN/HPR and IP configurations.

---

### Accessing NNP Functions

The APPN/HPR control point and IP router functions are located in the NNP and accessible via MOSS-E.

To access the functions of a NNP, follow the steps below:

- Step 1.** Open the 3746 menu (see “How to Use a Machine Menu” on page 3-8).
- Step 2.** Click **Network Node Processor (NNP) Management** to display NNP functions.

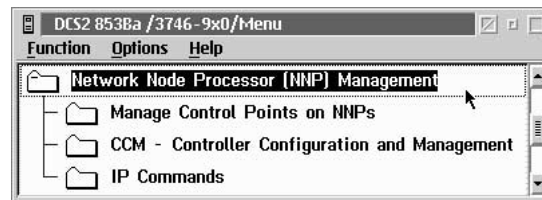

### Manage Control Points on NNPs

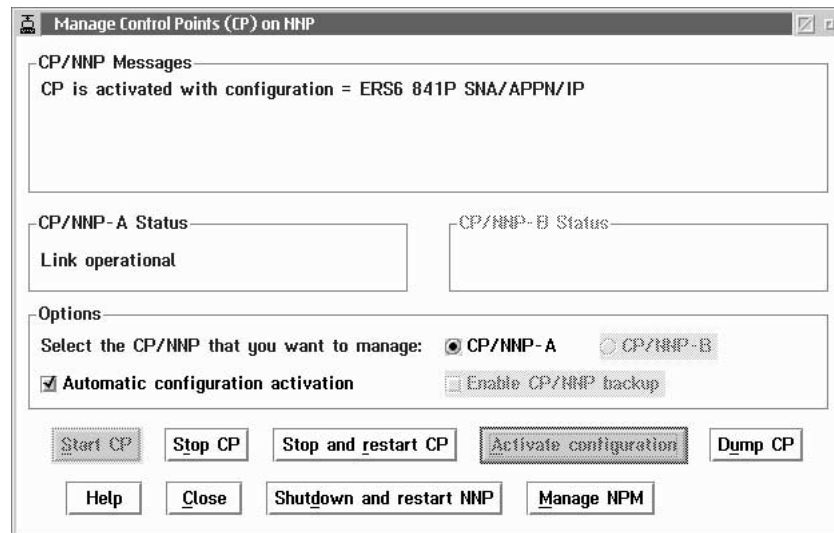

The following describes the buttons in the **Manage Control Points for NNPs** window.

## CP/NNP Messages Area

The message shows you the progress of a chosen function.

## CP/NNP-A (or -B) Status Areas

Information on the links between the service processor, network node processor, and controller. The status can be any of the following:

- Down
- Standby
- Waiting for operator activation
- Link not ready
- Link ready
- Link operational.

More status information is given in “NNP Status” on page 4-4.

## CP/NNP-A Radio Button

For working with NNP A control point functions.

## CP/NNP-B Radio Button

For working with the NNP B control point functions.

## Automatic Configuration Activation Option

Enables automatic resource activation after a network failure (see Table 4-1).

## Enable CP/NNP Backup Option

Activates dual NN functions (see Table 4-1).

Table 4-1. Control Point Management

Options	Status	Comments
Automatic Configuration Activation	Off	Click <b>Stop and restart</b> , <b>Shutdown and restart</b> , or an active <b>NNP failure</b> to stop all active sessions, and then restart the control point up to <b>Waiting for operator activation</b> status. Click <b>Activate configuration</b> to re-activate resources.
Enable CP/NNP Backup	Off	
Automatic Configuration Activation	On	<ul style="list-style-type: none"><li>• Click <b>Stop and restart</b> or <b>Shutdown and restart</b> to restart the control point, automatically reactivating the active configuration.</li><li>• An active <b>NNP failure</b> will drop the active sessions.</li></ul>
Enable CP/NNP Backup	Off	
Automatic Configuration Activation	Off	<ul style="list-style-type: none"><li>• No operator action available.</li><li>• An active <b>NNP failure</b> will activate the backup network node processor up to the <b>Waiting for operator activation</b> status.</li></ul> Then do the following: <ol style="list-style-type: none"><li>1. Set the <b>Enable CP/NNP backup</b> option to Off.</li><li>2. Click <b>Activate configuration</b> to reactivate resources.</li></ol>
Enable CP/NNP Backup	On	
Automatic Configuration Activation	On	<ul style="list-style-type: none"><li>• No operator action available.</li><li>• An active <b>NNP failure</b> results in the following:<ol style="list-style-type: none"><li>1. Activates and starts the backup network node processor.</li><li>2. Activates the configuration (dropping resources temporarily).</li><li>3. Reactivates active sessions.</li></ol></li></ul>
Enable CP/NNP Backup	On	

### **Start CP Button**

Initiates the control point program after using **Stop CP**.

### **Stop CP Button**

Ends the control point program without deactivating the network node resource configuration. Connecting to additional resources is no longer possible.

### **Stop and Restart CP Button**

Select this button to:

1. Stop control points.
2. Automatically restart the control point.
3. Automatically reactivates a configuration. This will only work if **Automatic configuration activation** is selected (see “Automatic Configuration Activation Option” on page 4-2).

### **Activate configuration Button**

Manually activates configuration of NN resources when **Automatic configuration activation** is not selected. Use this after the **Start CP** button.

### **Dump CP Button**

To be used only by an IBM representative.

### **Help Button**

Online information for managing the control point program.

### **Close Button**

Saves changes and returns to the previous panel.

### **Shutdown and Restart NNP Button**

Use this button to:

1. Stop the control point program and deactivate the configuration.
2. Shut down the NNP.
3. Restart the NNP.

Then, if **Automatic configuration activation** is selected:

4. Restart the CP program.
5. Re-activate the configuration.

### **Manage the NPM Push-Button**

Allows you to add, update, or remove a NetView Performance Monitor (NPM) configuration.

## NNP Status

The following describes the status of the NNP as indicated in the **Manage Control Points (CP) on NNP** window.

### Attention

If you select **Enable CP/NNP backup**, the configuration buttons will be unavailable. This is because priority is given to dual network node functions.

## Down Status

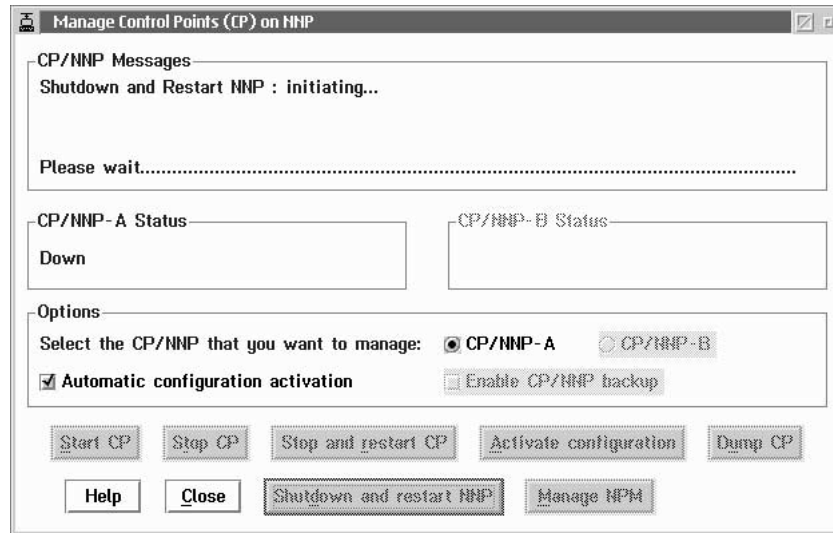

The NNP icon appears grey in color in the **MOSS-E View** window. This means that the link between the service processor and NNP has failed because of one of the following problems:

- Inactive service processor.
- Power OFF in the NNP.
- Defective cabling between the service processor and NNP.

For any of the above, see the online *Problem Analysis Guide*.

Click **Close** to exit.

## Standby Status

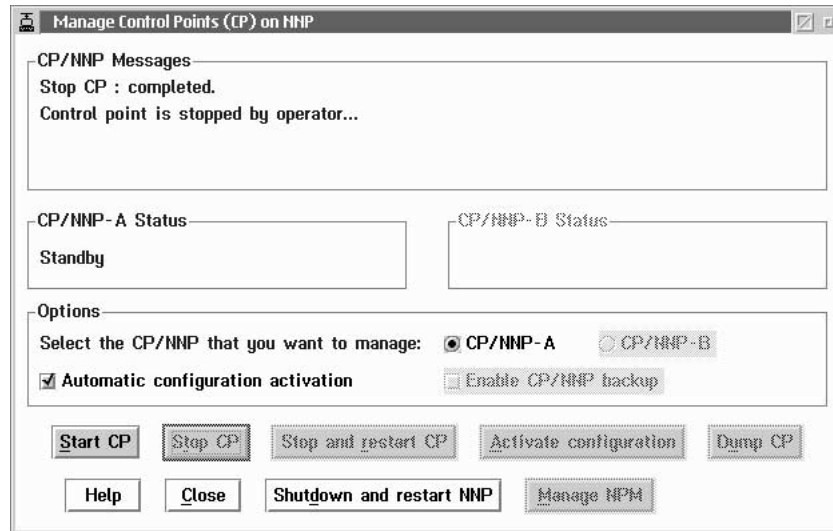

The NNP icon appears blue in color in the **MOSS-E View** window. This means that the NNP is active and ready for input. To select automatic configuration, click one of the following buttons:

- **Start CP** to initiate the control point program, ready for a configuration to be activated.
- **Shutdown and restart NNP** to:
  - Stop the control point program
  - Deactivate a configuration
  - Shut down and restart NNP
  - Restart the control point program
  - Re-activate a configuration.
- **Close** to save changes and exit.

To de-select automatic configuration, select one of the following buttons:

- **Start CP**, to initiate the control point program, ready for a configuration to be activated.
- **Shutdown and restart NNP** to:
  - Stop the control point program
  - Deactivate a configuration
  - Shut down and restart NNP
  - Restart the control point program
  - Re-activate a configuration.
- **Close** to save changes and exit.

## Waiting Operator Activation Status

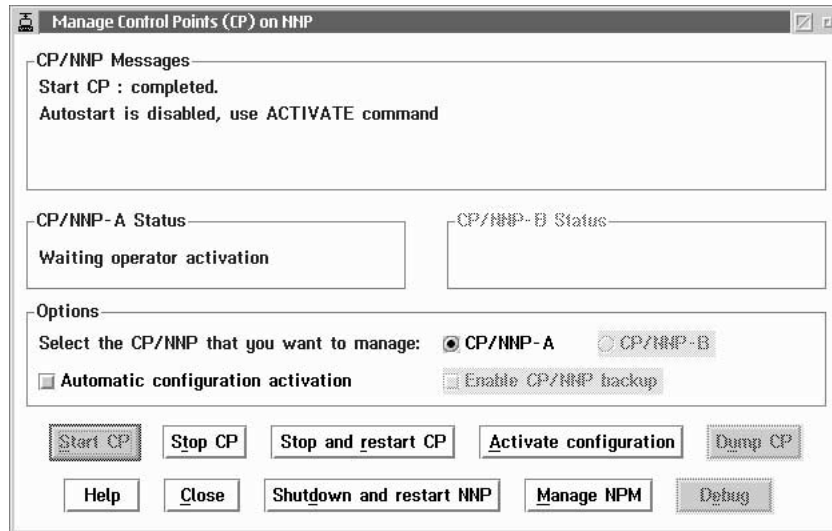

The NNP icon appears pink in color in the **MOSS-E** View window. This means that the NNP and control point program are ready but the configuration has not been activated. To activate a configuration, click one of the following buttons:

- **Activate configuration** completes the **Start CP** command by activating the NN.
- **Stop CP** ends the control point program and returns to **Standby** status.
- **Stop and restart CP** activates automatic configuration by:
  - Stopping the control point program
  - Deactivating the configuration
  - Restarting the control point program
  - re-activating the configuration.
- **Stop and restart CP**. This will de-select automatic configuration by:
  - Stopping the control point program
  - Deactivating the configuration
  - Restarting the control point program
  - Waiting for you to restart the configuration.
- **Close** saves changes and exits.



## Link Not Ready Status

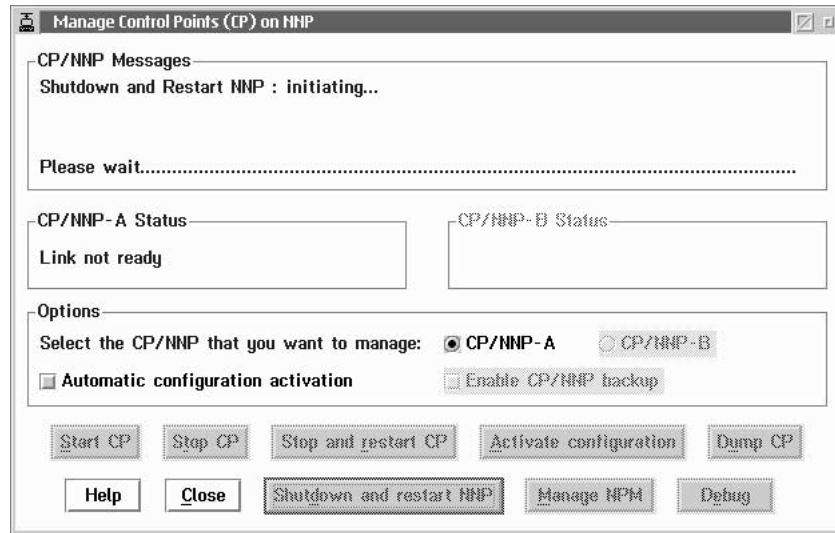

The NNP icon appears grey in color in the **MOSS-E View** window. This status means that the control point program is active and ready to be connected to the 3746.

There are no operator requirements.

## Link Ready Status

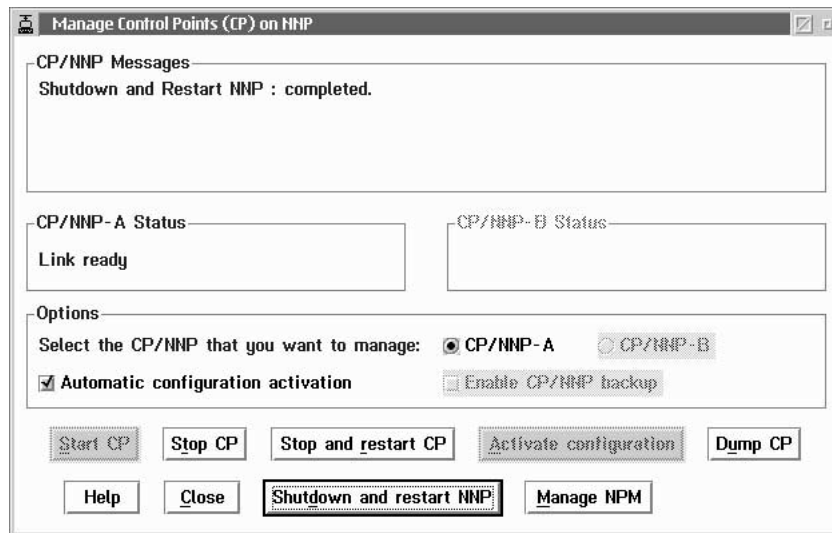

The NNP icon appears as white in color in the **MOSS-E View** window. This means that the NNP and control point are ready and the configuration is active. For further options, click the following buttons:

- **Stop CP** to end the control point program without deactivating the NN resource configuration.
- **Dump CP** is for IBM representatives only.
- Select Automatic configuration by clicking:
  - **Stop and restart CP**. This will do the following:
    - Stop and restart the 3746 control points
    - Automatically re-activate the configuration.
  - **Shutdown and restart NNP**. This will do the following:
    - Stop the control point program
    - Deactivate the configuration
    - Shut down the NNP
    - Restart the NNP
    - Restart the control point program
    - Re-activate the configuration.
- De-select automatic configuration by clicking:
  - **Stop and restart CP**. This will do the following:
    - Stop and restart the 3746 control points
    - Wait for your action.
  - **Shutdown and restart NNP** results in the following:
    - Stops the control point program
    - Deactivates the configuration
    - Shuts down the NNP
    - Restarts the NNP
    - Waits for your action.
- **Close** saves any changes and returns you to the previous panel.

## Link Operational Status

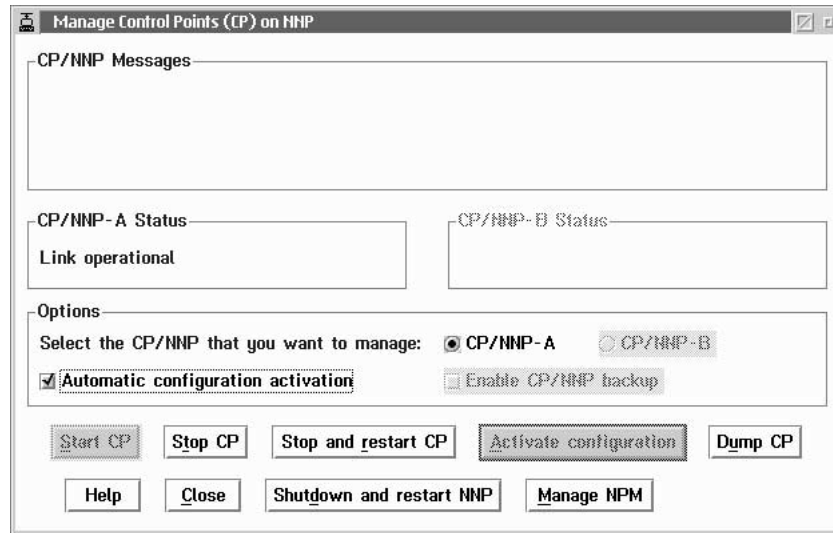

The NNP icon appears as green in color in the **MOSS-E View** window. This continues the **Link ready** status, and means that the control point is ready and the configuration is active.

## Controller Configuration and Management (CCM)

For configuring and managing APPN/HPR or IP resources in an OS/2 environment.

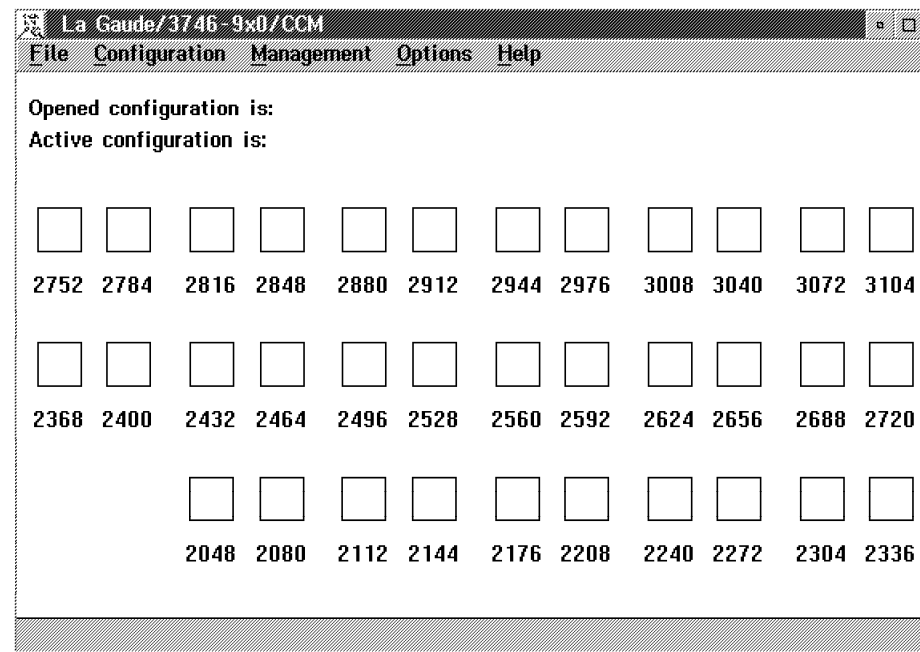

The above screen shows CCM without an open configuration.

Refer to Chapter 6, "Telnet IP Resource Management in CCM and MOSS-E" or to the *CCM: Users Guide*, SH11-3081.

## IP Commands

A method of configuring and managing IP resources using Telnet commands and without using CCM. Details about these commands are in “Accessing IP Commands from the MOSS-E” on page 6-4.

---

## Dual NNP

The 3746 can be equipped with one or two network node processors (NNPs) which provide the following:

- IP router functions.
- APPN/HPR control point functions including DLUR.
- Controller Configuration and Management (CCM) application.
- Storage utility for the network node files.

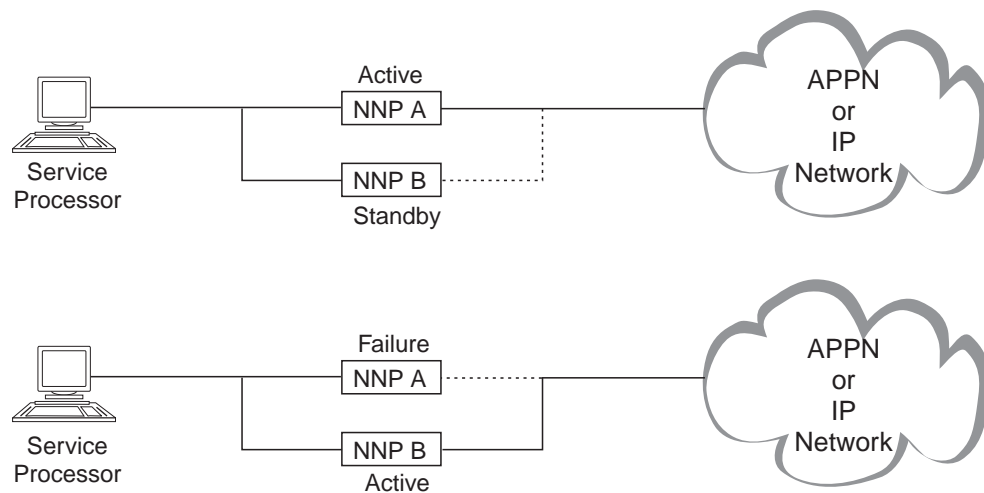

Figure 4-1. Dual Network Node Processors. Dual NNPs in twin-standby mode for 3745 Models 41A and 61A.

To activate dual NNP, select **Enable CP/NNP backup** (see “Manage Control Points on NNPs” on page 4-1).

Each NNP (A or B) can be in **active** or **standby** mode alternatively. The active NNP runs the APPN/HPR Control Point or IP router functions. The standby NNP takes control if the active NNP fails. The service processor monitors both NNPs, and if one fails, activates the standby NNP after a 2 minute timer confirmation. Choosing automatic configuration resets and restarts traffic for the 3746 NNP (see “NNP Status” on page 4-4). Otherwise, you must restart traffic manually.

## NNP States

In twin-standby mode, the NNPs display color status messages similar to the 3746 NNP (see “Information Pull-Down Menu” on page 3-7).

---

## Chapter 5. Working with Multiaccess Enclosure (MAE) Functions

---

### Introduction to the MAE

The MAE is designed primarily to provide a range of high-speed, high-availability connectivity options. Designed as a super processor, the MAE provides multiple types of network interfaces. The MAE enclosure houses eight adapter slots with up to eight ports per adapter. Performance attributes include routing for TCP/IP, SNA/DLUR, APPN, and HPR traffic. The MAE provides high port density and supports SDLC, PPP, Frame relay, and X.25 WAN protocols.

This chapter describes the specifications and functions of the newly released MAE, feature code 3001, which features a direct attachment to the controller switch. For more details, see “MAE with Direct Attachment.”

### Basic Functions in the MAE

The MAE base includes the following hardware:

- Power supply
- Cooling fan
- System card containing:
  - PowerPC microprocessor (200 Mhz).
  - 64 MB DRAM
  - PCMCIA token-ring card and cable (to connect the MAE to the service processor).
- Eight adapter slots

Licensed Internal Code for operating the MAE is pre-loaded before shipping.

### Prerequisites for MAE

- NNP or NNP type 2.
- Service processor type 2 (feature code 5052).
- IP routing (feature code 5033).
- Controller expansion<sup>1</sup>.

### MAE with Direct Attachment

The MAE with direct attachment to the 3746 controller switch, feature code 3001, includes a switch adapter card installed into the MAE and a switch interface extension installed into a 3746 processor slot. For IP traffic, this direct attachment frees the token-ring connection required for traffic routed between the MAE feature 3000 and the other enclosures of the 3746. Depending on the packet size and number of processors, the IP throughput between the MAE and the other enclosures of the 3746 is increased over five-fold, compared to dual token-ring connections.

---

<sup>1</sup> The cable for the MAE direct attachment is 9 m; this means that the controller expansion should be installed no more than 6 m from the 3746 controller.

## MAE Configurations in CCM

The MAE (feature code 3001) forms part of a single IP control point with the 3746. CCM provides an interface for managing the 3746 and the MAE in this single IP control point.

For a more detailed description on installing, configuring, and maintaining the MAE, see *Multiaccess Enclosure Installation and Maintenance*, SY33-2124.

To configure the MAE in CCM, use the following steps:

- Step 1** Double-click the 3746-900 machine object icon, or open the 3746-900 menu in the window list (see Step 2 on page 3-4).
- Step 2** Click **Network Node Processor (NNP) Management** then double-click **Controller Configuration and Management (CCM)**. The CCM main window displays (see Figure 5-1).

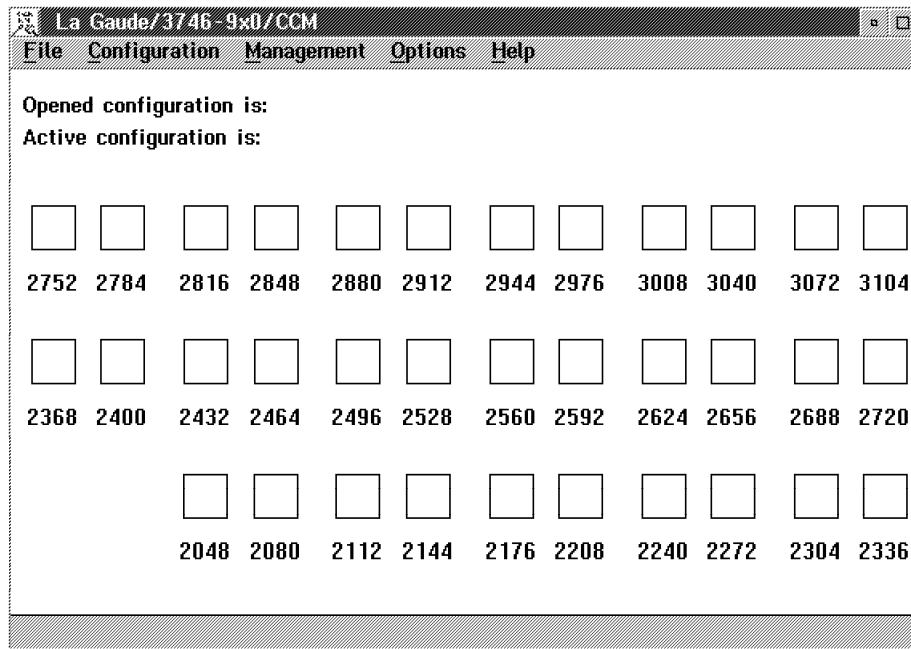
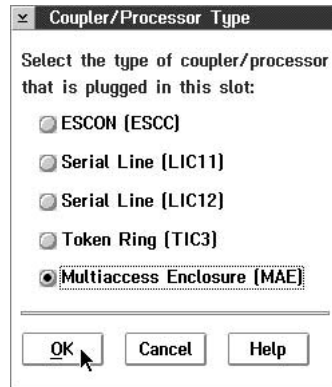

Figure 5-1. Controller Configuration and Management (CCM) Main Window

- Step 3** Click **Open** from the **File** menu. The **Configurations List** window displays.
- Step 4** Select the configuration that you want to modify and click **Open selected configuration**.
- Step 5** In the opened configuration, select the coupler number of the MAE, click the right mouse button and click **Configure coupler**.



**Step 6** Select **Multiaccess Enclosure (MAE)** and click **OK**.



**Step 7** The **Configuration Program**<sup>2</sup> opens. Configure the MAE and then close the **Configuration Program**. In CCM, the coupler number of the MAE appears with a check mark. The coupler to the right is automatically greyed out.

## Using the MAE Configuration Program

To modify MAE configurations with the **Configuration Program**, use the following steps.

**Step 1** Follow Steps 1 on page 5-2 to 4 on page 5-2.

**Step 2** In CCM, select the coupler number of the MAE.

**Step 3** Use the right mouse button to display the MAE menu and click **Configure coupler**.

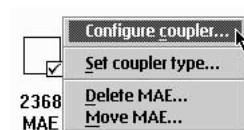

The **Configuration Program** opens.

<sup>2</sup> For more information on the MAE and the **Configuration Program**, see *Multiaccess Enclosure Installation and Maintenance*, SY33-2124.

## Accessing MAE Functions

To access MAE functions, use the following steps:

- Step 1.** Open the 3746 menu (see “How to Use a Machine Menu” on page 3-8).
- Step 2.** Click **Multiaccess Enclosure (MAE) Management** to display the MAE functions menu.

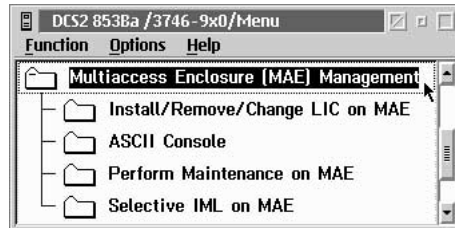

## Install/Remove/Change LIC on MAE

Code for running the MAE is down-loaded on the hard disk of the service processor during the installation of the service processor code. The **Install/Remove/Change LIC on MAE** function installs the MAE code on the service processor to the hard disk of the MAE.

- Step 1.** Double-click **Install/Remove/Change LIC on MAE**.

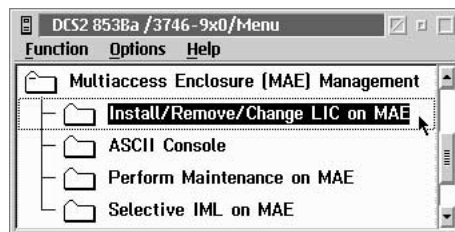

- Step 2.** Click **Install MAE** for a new installation of the MAE.

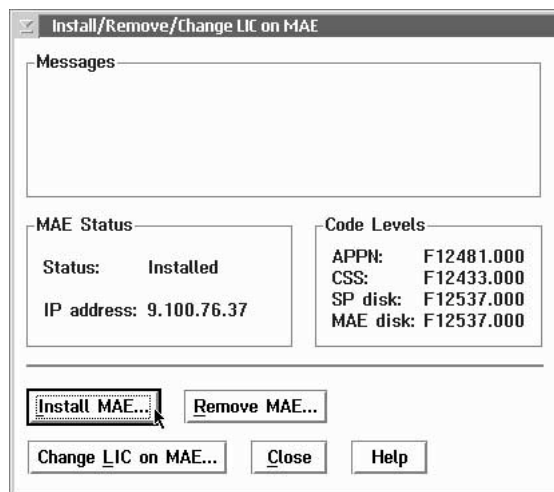

- Step 3.** Enter the IP address of the MAE.



See the following description of the buttons and status areas in the **Install/Remove/Change LIC on MAE** window.

### MAE Status

Indicates whether the MAE is installed and shows the IP address of the MAE.

### Code Levels

The current EC code level (a letter followed by a five-digit number) and MCL code level (a three-digit number) are shown for the 3746, the service processor, and the MAE. You can compare the code levels of the service processor and the MAE.

### Remove MAE

Removes the MAE from operation, for example, if your are moving the 3746 to a new location.

### Change LIC on MAE

Loads a new level of code from the service processor to the MAE hard disk.

## ASCII Console

This displays a **QVT - MAE** window for various MAE hardware configuration utilities. For example, you can set power-on and supervisory passwords, view and test MAE devices, select code levels, and setup the MAE hard disk. Also, you can use **ASCII Console** to run test procedures if the MAE is down or has a problem.

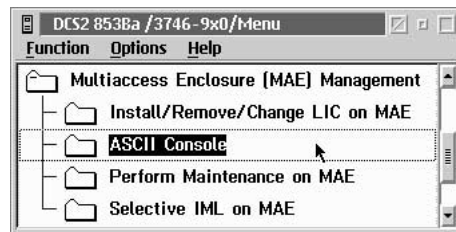

## Perform Maintenance on MAE

Disconnects the MAE from both 3746 and MAE traffic flows. After disconnecting, you can perform a maintenance check on the MAE. When the MAE is disconnected, the **MAE Link** icon in the **MOSS-E View** is red in color. This does not interfere with the operation of the 3746. After maintenance, you need to IML the MAE (see " Selective IML on MAE" on page 5-6).

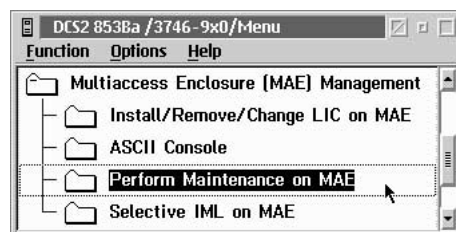

## Selective IML on MAE

This re-IMLs the MAE after a maintenance check. This should be done after any maintenance procedure is performed on the MAE, or if there is a problem with traffic flow and the code needs to be re-loaded. The IML may interfere with the traffic flow of the 3746. If you IML the 3746, this will stop traffic running in the MAE.

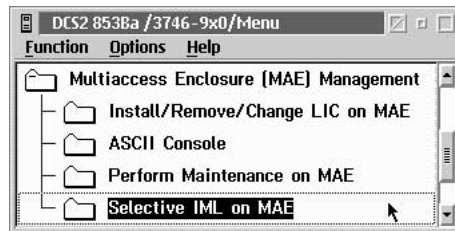

## Additional Information

For more information on the MAE, see the following publications:

- For information on MAE configuration parameters and technical specifications, see the *Planning Guide*, GA33-0457.
- For information on installation and maintenance procedures for the MAE, see *Multiaccess Enclosure Installation and Maintenance*, GA33-0457.
- For an overview of MAE functions, protocols, and interfaces, see *Overview*, GA33-0180.
- For other information, see *Software User's Guide*, SC30-3681.

---

## Chapter 6. Telnet IP Resource Management in CCM and MOSS-E

This section describes how to access and manage IP resources using Telnet commands via CCM or MOSS-E.

CCM provides menu options that access IP resources by running commands similar to Telnet (see “CCM IP Resource Management” on page 6-2).

You can also run Telnet commands for IP resources directly in MOSS-E (see “Accessing IP Commands from the MOSS-E” on page 6-4 for more information).

The advantage to directly accessing Telnet is that you do not need to use the resources of the service processor, which can then be reserved for other tasks.

For more information on CCM, see *CCM: Users Guide*, SH11-3081.

For more information on Telnet, see the *Nways Multiprotocol Routing Services*, SC30-3680 and the *Software User's Guide*, SC30-3681.

---

### Controller Configuration and Management (CCM)

CCM runs in the network node processor (NNP). You can open CCM on the service processor and use the application for the following:

- Defining configuration parameters for APPN and IP resources.
- Viewing configuration parameters.
- Performing management tasks.

The following describes how to configure CCM to access Telnet and run Telnet commands.

### CCM and Telnet User Profiles

First make sure that the MOSS-E option for configuring CCM and Telnet user profiles is enabled.

**Step 1** Double-click the service processor object icon or open an **MOSS-E View** menu from the window list (see Step 2 on page 3-4).

**Step 2** Click **Operation Management**.

**Step 3** Double-click **Manage Passwords**. Enter the management password (the default is **IBM3745**) and click **OK**.

**Step 4** Click **CCM/Telnet user profiles management**.



**Step 5** Enter a **Userid** and **Password** and click **OK**.

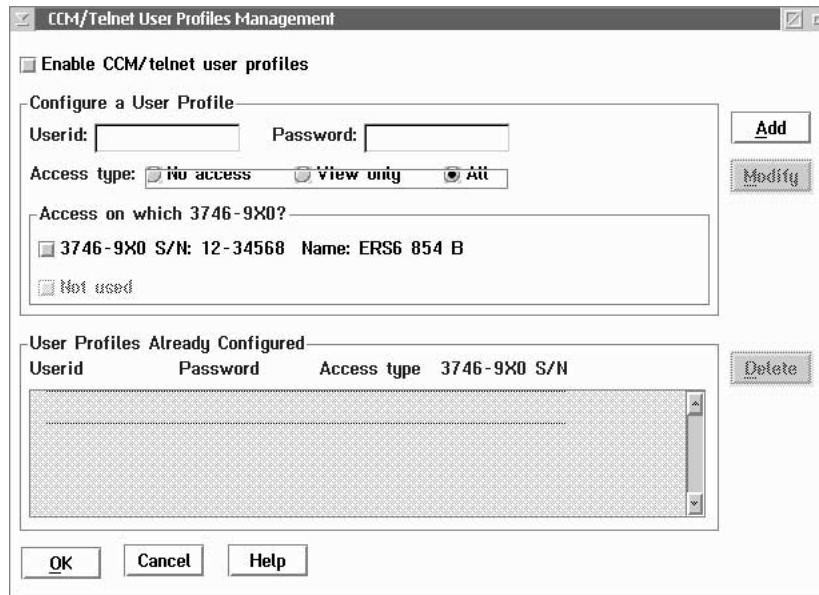

**Step 6** Click **Cancel** to exit.

---

## CCM IP Resource Management

You can configure IP resource management parameters by using the **Management** menu in CCM.

**Step 1** Double-click the 3746-900 machine object icon, or open the 3746-900 menu in the window list (see Step 2 on page 3-4).

**Step 2** Click **Network Node Processor (NNP) Management** then double-click **Controller Configuration and Management (CCM)**. The CCM main window displays.

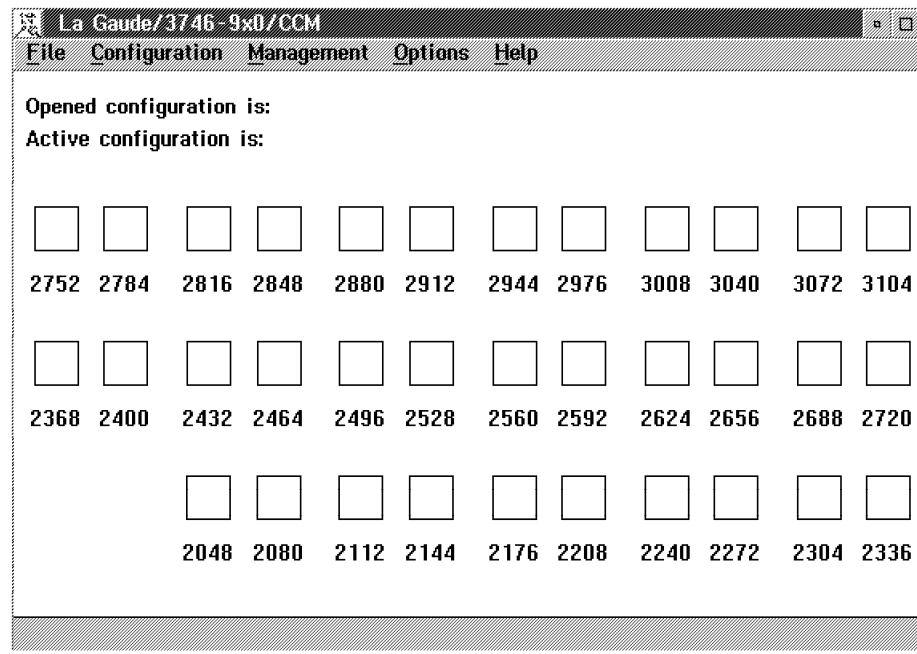
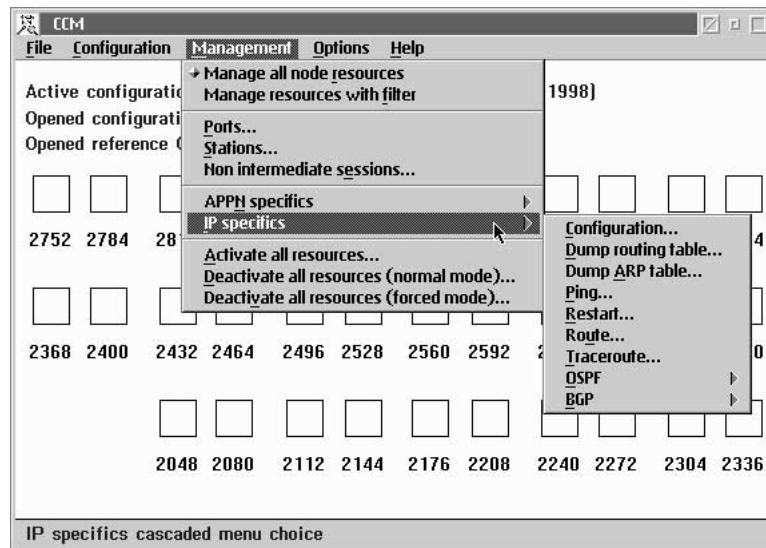

Figure 6-1. Controller Configuration and Management (CCM) Main Window

**Step 3** Open the **Management** menu, and click **IP specifics**.



**Step 4** CCM commands for Telnet functions are listed in the **IP specifics** sub-menus. For more detailed information on using CCM commands for IP management, see the *Planning Guide*, GA33-0457.

---

## Accessing IP Commands from the MOSS-E

First make sure that the MOSS-E option for configuring CCM and Telnet user profiles is enabled (see “CCM and Telnet User Profiles” on page 6-1).

**Step 1** Double-click a 3746-900 machine object icon, or open a 3746-900 menu in the window list (see Step 2 on page 3-4).

**Step 2** Click **Network Node Processor (NNP) Management**, then double-click **IP Commands**.

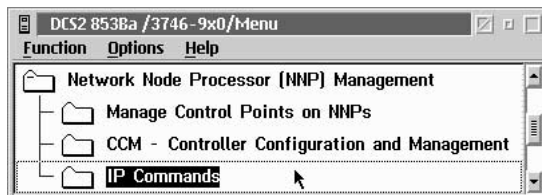

**Step 3** Enter your **Userid** and **Telnet Password** to access the OPCON environment (see “Navigating in the IP Environment” for more information on OPCON).

**Note:** You can enter your own userid and password or the default Telnet values of **NNPIP** and **37469X0A**.

**Step 4** At the Telnet *RANGE XXXX-YYYY \** command line, you can configure and manage available IP resources (see “Configuring Resources” on page 6-5 and “Managing Resources” on page 6-6).

## Navigating in the IP Environment



IP is divided in three main environment levels (see Figure 6-2 on page 6-5).

**Level 1** OPCON environment.

**Level 2** CONFIG (T 6) environment for configuration, or GWCON (T 5) environment for management.

**Level 3** Protocol environments (Netxxxx, P ARP, P IP, P OSPF, P BGP).

You can configure and manage IP resources within these levels. Navigating these levels requires the following simple commands:

- Level 3 commands allow you into a specified environment.
- Typing **EXIT** returns you to the previous level.
- Pressing  and  together returns you from the environment that you are in back to OPCON (the *RANGE XXXX-YYYY \** command prompt).

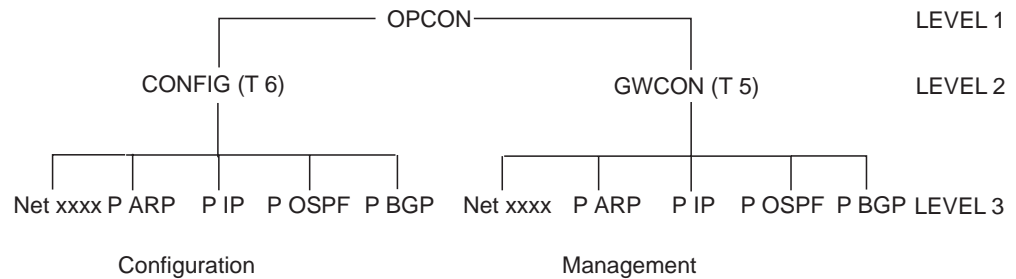



### Legend

**xxxx** Port number

Figure 6-2. Internet Protocol (IP) Environment

## OPCON Commands

At the OPCON command prompt **RANGE XXXX-YYYY \***, enter **?** for available OPCON commands.

- Logout** Exits the Telnet session without saving changes (the keyboard shortcut is pressing  and  together).
- Memory** Displays information on adapter memory.
- Range** Selects an adapter by specific port number.
- Restart** Restarts the IP router with the current or new configuration.
- Status** Displays the status of adapter processes.
- Talk** For configuration (Talk 6 or T 6) or management (Talk 5 or T 5) IP.

For working on a specific processor, you can use the port number, interface number, or port name in OPCON and GWCON environments. The command prompt automatically updates to the processor that you are working on.



Commands that include a port number, interface number, or port name, take you automatically to the appropriate processor.

Some commands include a parameter for entering a port number (for example, BUFFER). If a parameter is entered, the command applies to the specified address. Otherwise, the command applies to the entire processor.



## Configuring Resources

For a more detailed description on using these commands, see *Nways Multiprotocol Routing Services*, and the *Software User's Guide*.

- Step 1** On the **Range XXXX-YYYY \*** command line, enter **T 6** for the **Config>** command prompt.
- Step 2** Enter **?** to display the list of the available configuration commands.
  - Exit** Returns to the previous environment level.
  - List** Displays the configuration and devices list.

<b>Logout</b>	Exits the Telnet session without saving changes (the keyboard shortcut is pressing  and  together).
<b>Network</b>	Enters the configuration network (port) environment.
<b>Patch</b>	Used only by an IBM representative.
<b>Protocol</b>	For entering a protocol environment (IP, ARP, etc).
<b>Set</b>	For setting parameters.
<b>Unpatch</b>	Used only by an IBM representative.

**Step 3** Entering ? after a command name displays any associated sub-commands.



Pressing  and  together returns you from the environment that you are in back to OPCON (the *RANGE XXXX-YYYY \** command prompt).

## Managing Resources

For detailed use of these commands, refer to the *Nways Multiprotocol Routing Services* and to the *Software User's Guide*.

**Step 1** On the **Range XXXX-YYYY \*** command line, enter **T 5** to display the GWCON command prompt (shown as **RANGE XXXX-YYYY +**).



**Step 2** Enter ? to display the list of the available management commands.

<b>Range</b>	For other adapter range addresses.
<b>Buffer</b>	Displays the interface buffer size and utilization.
<b>Clear</b>	For clearing interface statistics.
<b>Configuration</b>	Displays adapter protocol and interface configuration.
<b>Disable</b>	Disables adapter interfaces.
<b>Error</b>	Displays interface error statistics.
<b>Interface</b>	Displays interface statistics.
<b>Logout</b>	Exits the Telnet session without saving changes (the keyboard shortcut is pressing  and  together).
<b>Memory</b>	Displays memory information.
<b>Network</b>	For entering a network (or port) environment.
<b>Protocol</b>	For entering a protocol environment.
<b>Queue</b>	Displays interface queue length.
<b>Statistics</b>	Displays interface traffic.
<b>Test</b>	For enabling or verifying an adapter interface.
<b>Uptime</b>	Display the time statistics of an adapter.
<b>Debug</b>	Used by an IBM representative only.
<b>Phdump</b>	Used by an IBM representative only.



**Trcon**            Used by an IBM representative only.  
**Trcoff**           Used by an IBM representative only.

**Step 3** Enter ? after a command name to display any available associated sub-commands.

Pressing  and  together returns you from the environment that you are in back to OPCON (the *RANGE XXXX-YYYY \** command prompt).

---

## Single IP Control Point for the 3746 and the MAE



The 3746 and the MAE (feature code 3001) share a single IP control point. You can use the **IP Commands** function of the **Network Node Processor (NNP) Management** menu to display the resources of the 3746 and the MAE. However, if you display the resources of the 3746, only the coupler assigned to the MAE is initially shown. To access the interfaces configured for the MAE, use the following procedure.

**Step 1** Follow Steps 1 on page 6-4 to 3 on page 6-4.

**Step 2** At the Telnet *RANGE XXXX-YYYY \** command line, type **T 5**.

**Step 3** Type **Net xxxx** (where **xxxx** represents the coupler number of the MAE).

A warning message informs you that using the **T 6** command to modify any interface or IP address will cause the MAE to malfunction.

**Step 4** Type **T 5**, then **c** to display the interfaces of the MAE. Press  to display information on MAE interfaces line by line. If you want to view information screen by screen, press  and the space-bar.

**Step 5** To return to the previous level, type **Range 0**.

## MONITR Process

The MONITR process displays the activity inside the router and the network. To access MONITR from OPCON, type **T 2**.



# Chapter 7. 3745 Power ON and IPL from Control Panel

**Note:** Throughout this and the following chapters, you may find it useful to refer to Appendix A, "3745 Operator Control Panel."

## 3745 Manual Power ON and IPL

The control program can be loaded into the CCU by one of the following methods:

- Parallel or ESCON channel from the host.
- A link IPL port from the host.
- Fixed disk with the control program, activated by a host operator.

**Note:** If you are operating in twin-standby mode, a control program loaded into the active CCU will be automatically loaded into the standby CCU.

### Step 1

Is the <b>Service Mode</b> set to 0?	
<b>Yes</b>	Go to Step 2.
<b>No</b>	1. Press <b>Service Mode</b> repeatedly until <b>0</b> is displayed.
	2. Press <b>Validate</b> .
	3. Is the 3745 already powered <b>ON</b> ?
<b>Yes</b>	Go to Step 4.
<b>No</b>	Go to Step 2.

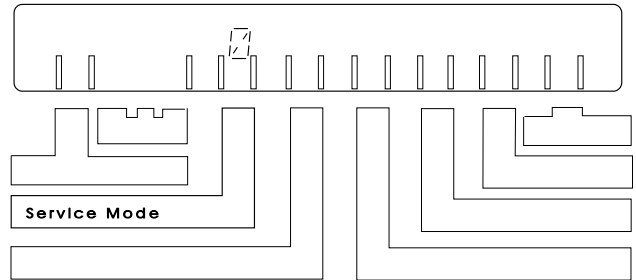

### Step 2

Is the <b>Power Control</b> set to 3?	
<b>Note:</b> <b>Power Control 3</b> (local mode) is not recommended for normal operations. It is intended for service operations, and if the controller is left in local mode, you will have to manually power ON if there is a power failure.	
<b>Yes</b>	Go to Step 3.
<b>No</b>	1. Note the <b>Power Control</b> setting so that you can reset it at the end of this procedure.
	2. Press <b>Power Control</b> repeatedly until <b>3</b> displays.
	3. Press <b>Validate</b> and go to Step 3.

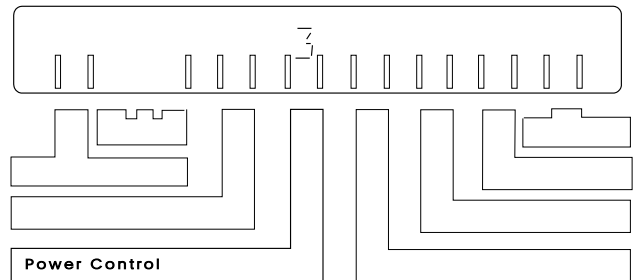

## Step 3

Do you want to power ON the 3746-9x0 at the same time as the 3745?					
<b>Yes</b>	Is the 3746-9x0 <b>Power Control</b> set to 1?				
	<table border="1"> <tr> <td><b>Yes</b></td> <td>Go to Step 4.</td> </tr> <tr> <td><b>No</b></td> <td> <ol style="list-style-type: none"> <li>1. Press the 3746-9x0 <b>Power Control</b> repeatedly until 1 displays.</li> <li>2. Press <b>Validate</b> and go to Step 4.</li> </ol> </td> </tr> </table>	<b>Yes</b>	Go to Step 4.	<b>No</b>	<ol style="list-style-type: none"> <li>1. Press the 3746-9x0 <b>Power Control</b> repeatedly until 1 displays.</li> <li>2. Press <b>Validate</b> and go to Step 4.</li> </ol>
<b>Yes</b>	Go to Step 4.				
<b>No</b>	<ol style="list-style-type: none"> <li>1. Press the 3746-9x0 <b>Power Control</b> repeatedly until 1 displays.</li> <li>2. Press <b>Validate</b> and go to Step 4.</li> </ol>				
<b>No</b>	Is the 3746-9x0 <b>Power Control</b> set to 3?				
	<table border="1"> <tr> <td><b>Yes</b></td> <td>Go to Step 4.</td> </tr> <tr> <td><b>No</b></td> <td> <ol style="list-style-type: none"> <li>1. Press the 3746-9x0 <b>Power Control</b> repeatedly until 3 displays.</li> <li>2. Press <b>Validate</b> and go to Step 4.</li> </ol> </td> </tr> </table>	<b>Yes</b>	Go to Step 4.	<b>No</b>	<ol style="list-style-type: none"> <li>1. Press the 3746-9x0 <b>Power Control</b> repeatedly until 3 displays.</li> <li>2. Press <b>Validate</b> and go to Step 4.</li> </ol>
	<b>Yes</b>	Go to Step 4.			
<b>No</b>	<ol style="list-style-type: none"> <li>1. Press the 3746-9x0 <b>Power Control</b> repeatedly until 3 displays.</li> <li>2. Press <b>Validate</b> and go to Step 4.</li> </ol>				

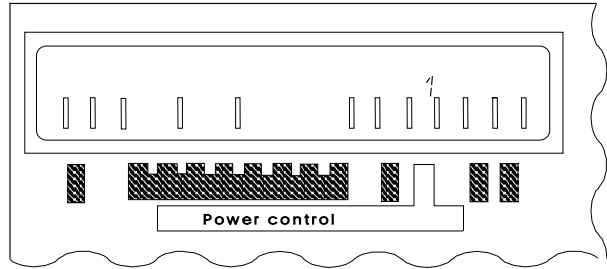

## Step 4

Is the 3745 <b>Function</b> set to 0?	
<b>Yes</b>	Go to Step 5.
<b>No</b>	<ol style="list-style-type: none"> <li>1. Press <b>Function</b> repeatedly until 0 is displayed.</li> <li>2. Press <b>Validate</b>.</li> <li>3. Go to Step 5.</li> </ol>

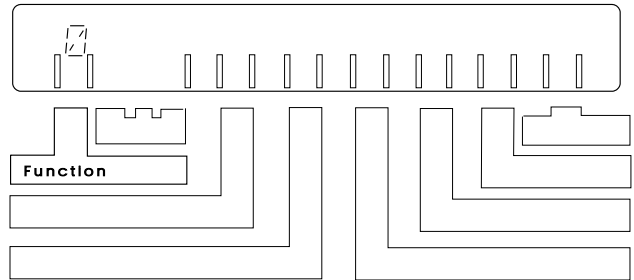

## Step 5

Press **Power ON Reset**.

A general IPL starts (IML of MOSS and IPL of CCUs). This takes about five minutes. Hex codes on the display show the progress of the IPL. Page A-9 gives an explanation of these codes.

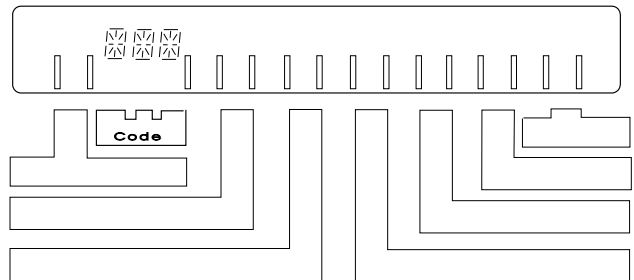

## Step 6

Is the host loading the control program?									
<b>Yes</b>	Have any hex codes remained displayed for more than five minutes (other than <b>FF4</b> )?								
	<table border="1"> <tr> <td><b>Yes</b></td> <td> <ol style="list-style-type: none"> <li>Go back to Step 5 and reset the 3745.</li> <li>If the problem persists, contact the person in charge of 3745 problem analysis (see page 1-5).</li> </ol> </td> </tr> <tr> <td><b>No</b></td> <td> <ol style="list-style-type: none"> <li>Open a MOSS window at the service processor (see page 3-10).</li> <li>Wait until the screen at the right displays. →</li> <li>Do you need to enable or disable a channel adapter?</li> </ol> </td> </tr> <tr> <td><b>Yes</b></td> <td> <ol style="list-style-type: none"> <li>To enable or disable: <ul style="list-style-type: none"> <li>3745 channel adapters, see 2 on page 10-1.</li> <li>3746-9x0 ESCON channel adapters, see page 10-2.</li> </ul> </li> <li>Go to Step 7.</li> </ol> </td> </tr> <tr> <td><b>No</b></td> <td>Go to Step 7.</td> </tr> </table>	<b>Yes</b>	<ol style="list-style-type: none"> <li>Go back to Step 5 and reset the 3745.</li> <li>If the problem persists, contact the person in charge of 3745 problem analysis (see page 1-5).</li> </ol>	<b>No</b>	<ol style="list-style-type: none"> <li>Open a MOSS window at the service processor (see page 3-10).</li> <li>Wait until the screen at the right displays. →</li> <li>Do you need to enable or disable a channel adapter?</li> </ol>	<b>Yes</b>	<ol style="list-style-type: none"> <li>To enable or disable: <ul style="list-style-type: none"> <li>3745 channel adapters, see 2 on page 10-1.</li> <li>3746-9x0 ESCON channel adapters, see page 10-2.</li> </ul> </li> <li>Go to Step 7.</li> </ol>	<b>No</b>	Go to Step 7.
	<b>Yes</b>	<ol style="list-style-type: none"> <li>Go back to Step 5 and reset the 3745.</li> <li>If the problem persists, contact the person in charge of 3745 problem analysis (see page 1-5).</li> </ol>							
	<b>No</b>	<ol style="list-style-type: none"> <li>Open a MOSS window at the service processor (see page 3-10).</li> <li>Wait until the screen at the right displays. →</li> <li>Do you need to enable or disable a channel adapter?</li> </ol>							
<b>Yes</b>	<ol style="list-style-type: none"> <li>To enable or disable: <ul style="list-style-type: none"> <li>3745 channel adapters, see 2 on page 10-1.</li> <li>3746-9x0 ESCON channel adapters, see page 10-2.</li> </ul> </li> <li>Go to Step 7.</li> </ol>								
<b>No</b>	Go to Step 7.								
<b>No</b>	Go to Step 8.								

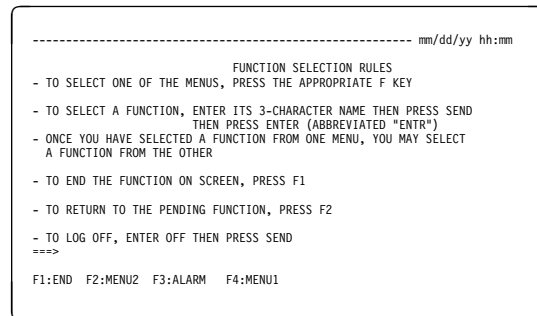

## Step 7

Is <b>FF4</b> displayed?	
<b>Yes</b>	<ol style="list-style-type: none"> <li>Ask the host operator to load the control program.  The progress of the IPL is shown on the code display.</li> <li>Go to Step 8.</li> </ol>
	<b>No</b>

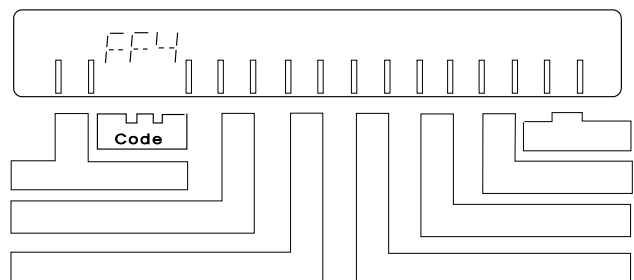

## Step 8

Is <b>000</b> displayed?									
<b>Yes</b>	1. The IPL of one CCU is successful. 2. Is the 3745 in twin-standby mode?								
	<table border="1"> <tr> <td><b>Yes</b></td> <td>Go to Step 9.</td> </tr> <tr> <td><b>No</b></td> <td>Go to Step 12.</td> </tr> </table>	<b>Yes</b>	Go to Step 9.	<b>No</b>	Go to Step 12.				
<b>Yes</b>	Go to Step 9.								
<b>No</b>	Go to Step 12.								
<b>No</b>	Has <b>FF4</b> remained displayed for more than two minutes.								
	<table border="1"> <tr> <td><b>Yes</b></td> <td>Go to Step 10.</td> </tr> <tr> <td><b>No</b></td> <td>Is there another code displayed?</td> </tr> <tr> <td><b>Yes</b></td> <td>Go to page A-9.</td> </tr> <tr> <td><b>No</b></td> <td>Contact the person in charge of 3745 problem analysis (see page 1-5).</td> </tr> </table>	<b>Yes</b>	Go to Step 10.	<b>No</b>	Is there another code displayed?	<b>Yes</b>	Go to page A-9.	<b>No</b>	Contact the person in charge of 3745 problem analysis (see page 1-5).
	<b>Yes</b>	Go to Step 10.							
	<b>No</b>	Is there another code displayed?							
<b>Yes</b>	Go to page A-9.								
<b>No</b>	Contact the person in charge of 3745 problem analysis (see page 1-5).								

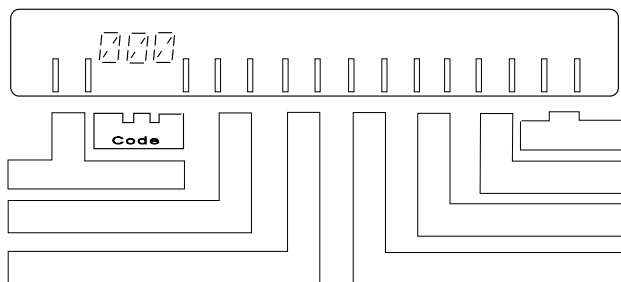

## Step 9

The IPL of the standby CCU starts. Hex codes on the display show the progress of the IPL. Wait for two minutes.

Is <b>000</b> displayed <b>again</b> ?								
<b>Yes</b>	1. The IPL of the standby CCU is successful. 2. Go to Step 12.							
	<table border="1"> <tr> <td><b>Yes</b></td> <td>Go to Step 10.</td> </tr> <tr> <td><b>No</b></td> <td>Are there other codes displayed?</td> </tr> <tr> <td><b>Yes</b></td> <td>Go to page A-9.</td> </tr> <tr> <td><b>No</b></td> <td>Contact the person in charge of 3745 problem analysis (see page 1-5).</td> </tr> </table>	<b>Yes</b>	Go to Step 10.	<b>No</b>	Are there other codes displayed?	<b>Yes</b>	Go to page A-9.	<b>No</b>
<b>Yes</b>	Go to Step 10.							
<b>No</b>	Are there other codes displayed?							
<b>Yes</b>	Go to page A-9.							
<b>No</b>	Contact the person in charge of 3745 problem analysis (see page 1-5).							

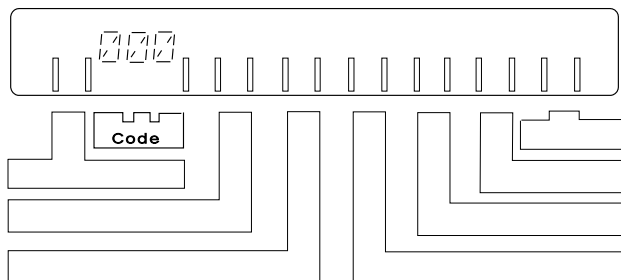

## Step 10

Is there a 3746-9x0 ESCON link for the IPL port?	
<b>Yes</b>	Does the 3746-9x0 object display an alarm in the <b>MOSS-E View</b> window?
	<b>Yes</b>
	<b>No</b>
	<b>No</b>
<b>No</b>	Go to Step 11.

## Step 11

Make sure a MOSS window is open at the service processor (see page 3-10). Wait until the following screen displays:

```

COMMCTAL ID: IBM La Gaudie          3745-61A      SERIAL NUMBER:
CCU-A      PROCESS MOSS-OFFLINE
RUN      BYP-IDC-CHK STOP-CCU-CHK
IPL CCU-A PHASE 3      ENABLED CA YN----- L -----
CCU-B      PROCESS MOSS-OFFLINE
RUN      BYP-IDC-CHK STOP-CCU-CHK
IPL CCU-B PHASE 3      ENABLED CA ----Y----- L -----
FUNCTION ON SCREEN: IPL CCU(S)
                      CCU AND SCANNER IPL

                WHEN THIS FUNCTION IS COMPLETE (SEE ABOVE), PRESS F1

===>
F1:END  F2:MENU2          F4:STOP  F5:RESUME

```

Is the active CA or link IPL port marked <b>Y</b> ?	
<b>Yes</b>	Contact the person in charge of 3745 problem analysis (see page 1-5).
<b>No</b>	Is the active CA or link IPL port marked <b>N</b> ?
	<b>Yes</b>
	<b>No</b>
	<b>No</b>
<b>No</b>	When <b>000</b> displays, go to Step 12.

## Step 12

Is the <b>Power Control</b> set to the number noted from Step 2?	
<b>Yes</b>	Go to Step 13.
<b>No</b>	<ol style="list-style-type: none"> <li>1. Press <b>Power Control</b> repeatedly until the number that you noted displays.</li> <li>2. Press <b>Validate</b> and go to Step 13.</li> </ol>

## Step 13

To see if resources are available, do the following in MOSS-E:

1. Click the **3745** icon.
2. In **Program** menu, select **Status**. This will display the color legend.

## 3745 Automatic Power ON and IPL

An automatic power ON and IPL can be performed in two ways, either by the host, or by the 3745 at a scheduled time.

The following procedure applies to both of the above, with a slight difference in the last step. When the **Power Control** mode is set to **1**, this applies to the host, and when it is set to **2**, this applies to the scheduled time (for more information, see "Power Control Display" on page A-5).

### Step 1

Open a MOSS window at the service processor (see page 3-10).

Is the screen on the right displayed? →	
<b>Yes</b>	Go to Step 8.
<b>No</b>	Go to Step 2.

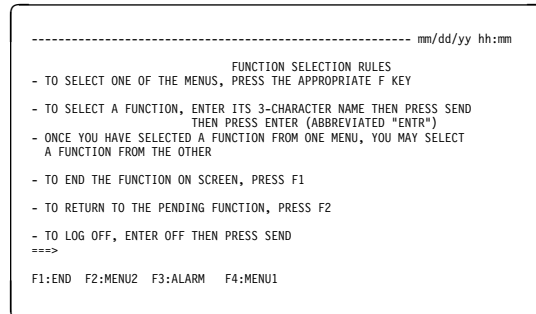

### Step 2

Is <b>Service Mode</b> set to <b>0</b> ?	
<b>Yes</b>	Go to Step 3.
<b>No</b>	<ol style="list-style-type: none"> <li>1. Press <b>Service Mode</b> repeatedly until <b>0</b> is displayed.</li> <li>2. Press <b>Validate</b>.</li> <li>3. Go to Step 3.</li> </ol>

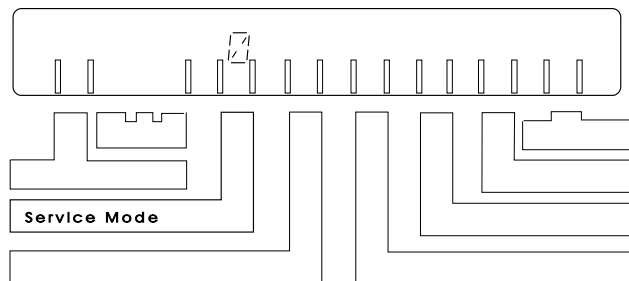



## Step 3

Do you want to power ON the 3746-9x0 at the same time as the 3745?					
<b>Yes</b>	Is 3746-9x0 <b>Power Control</b> set to 1?				
	<table border="1"> <tr> <td><b>Yes</b></td> <td>Go to Step 4.</td> </tr> <tr> <td><b>No</b></td> <td> <ol style="list-style-type: none"> <li>1. Press 3746-9x0 <b>Power Control</b> repeatedly until 1 displays.</li> <li>2. Press <b>Validate</b> and go to Step 4.</li> </ol> </td> </tr> </table>	<b>Yes</b>	Go to Step 4.	<b>No</b>	<ol style="list-style-type: none"> <li>1. Press 3746-9x0 <b>Power Control</b> repeatedly until 1 displays.</li> <li>2. Press <b>Validate</b> and go to Step 4.</li> </ol>
<b>Yes</b>	Go to Step 4.				
<b>No</b>	<ol style="list-style-type: none"> <li>1. Press 3746-9x0 <b>Power Control</b> repeatedly until 1 displays.</li> <li>2. Press <b>Validate</b> and go to Step 4.</li> </ol>				
<b>No</b>	Is 3746-9x0 <b>Power Control</b> set to 3?				
	<table border="1"> <tr> <td><b>Yes</b></td> <td>Go to Step 4.</td> </tr> <tr> <td><b>No</b></td> <td> <ol style="list-style-type: none"> <li>1. Press the 3746-9x0 <b>Power Control</b> repeatedly until 3 displays.</li> <li>2. Press <b>Validate</b> and go to Step 4.</li> </ol> </td> </tr> </table>	<b>Yes</b>	Go to Step 4.	<b>No</b>	<ol style="list-style-type: none"> <li>1. Press the 3746-9x0 <b>Power Control</b> repeatedly until 3 displays.</li> <li>2. Press <b>Validate</b> and go to Step 4.</li> </ol>
	<b>Yes</b>	Go to Step 4.			
<b>No</b>	<ol style="list-style-type: none"> <li>1. Press the 3746-9x0 <b>Power Control</b> repeatedly until 3 displays.</li> <li>2. Press <b>Validate</b> and go to Step 4.</li> </ol>				

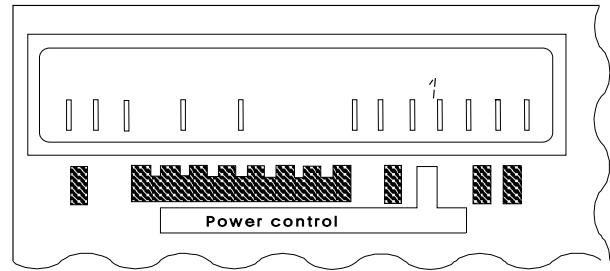

## Step 4

Is the 3745 <b>Power Control</b> set to 3?	
<b>Yes</b>	Go to Step 5.
<b>No</b>	<ol style="list-style-type: none"> <li>1. Press <b>Power Control</b> repeatedly until 3 displays.</li> <li>2. Press <b>Validate</b>.</li> <li>3. Go to Step 5.</li> </ol>

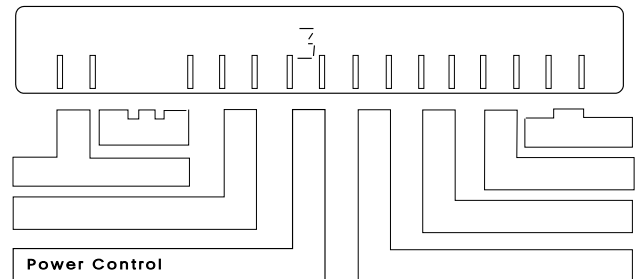

## Step 5

Is the 3745 <b>Function</b> set to 1?					
<b>Yes</b>	Go to Step 6.				
<b>No</b>	<ol style="list-style-type: none"> <li>1. Press <b>Function</b> repeatedly until 1 is displayed.</li> <li>2. Press <b>Validate</b>.</li> <li>3. Is the 3745 already powered <b>ON</b>?</li> </ol>				
	<table border="1"> <tr> <td><b>Yes</b></td> <td>Go to Step 7.</td> </tr> <tr> <td><b>No</b></td> <td>Go to Step 6.</td> </tr> </table>	<b>Yes</b>	Go to Step 7.	<b>No</b>	Go to Step 6.
	<b>Yes</b>	Go to Step 7.			
<b>No</b>	Go to Step 6.				

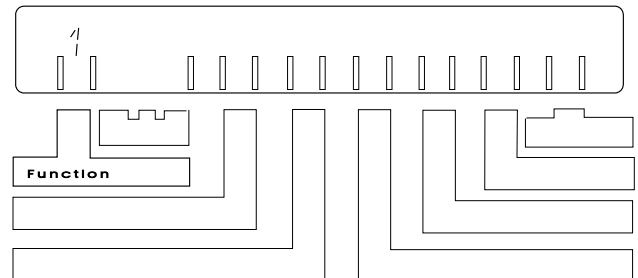

## Step 6

Press **Power On Reset**.

## Step 7

The MOSS IML starts and takes a few minutes. Hex codes on the display show the progress of the IML.

Is <b>F0E</b> or <b>F0F</b> displayed?	
<b>Yes</b>	Go to Step 8.
<b>No</b>	Contact the person in charge of 3745 problem analysis (see page 1-5).

## Step 8

Type **CID** and press .

Is a screen similar to the one on the right displayed? →	
<b>Yes</b>	Go to Step 9.
<b>No</b>	Contact the person in charge of 3745 problem analysis (see page 1-5).

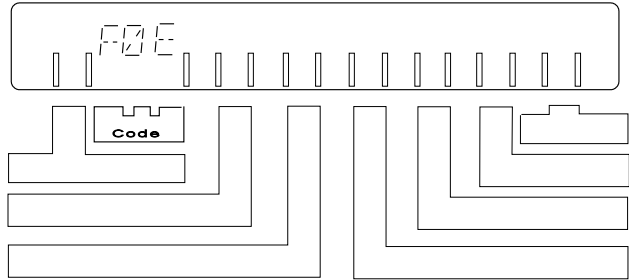

```

COMMCTRLID :xxxxxxxx      3745-XXX      SERIAL NUMBER:nnnnnn
                          3745 MICROCODE (C) COPYRIGHT IBM CORP. 1987
                          mm/dd/yy hh:mm

FUNCTION ON SCREEN: CA INTERF DISPLAY
INTERFACE CHANGE E/D INTERF
NUMBER E/D REQ REQUEST STATUS
HOST OR CHANNEL NSC
SWITCH UNIT ADDRESS ADDRESS

1A ==> D DISABLED FA
2A ==> E ENABLED FB
3A ==> E ENABLED 0C
4A ==> D DISABLED 11
5A ==> D DISABLED FC
6A ==> E ENABLED FD
7A - -
8A - -

- TYPE E OR D TO CHANGE THE ENABLE/DISABLE REQUEST, THEN PRESS SEND
==>

F1:END      F3:ALARM      F5:UPDATE
    
```

## Step 9

Use the **CA INTERF DISPLAY** screen below to enable or disable channel adapters as necessary:

```



COMMCTRLID :xxxxxxxx      3745-XXX      SERIAL NUMBER:nnnnnn
                          3745 MICROCODE (C) COPYRIGHT IBM CORP. 1987
                          mm/dd/yy hh:mm

FUNCTION ON SCREEN: CA INTERF DISPLAY
INTERFACE CHANGE E/D INTERF
NUMBER E/D REQ REQUEST STATUS
HOST OR CHANNEL NSC
SWITCH UNIT ADDRESS ADDRESS

1A ==> D DISABLED FA
2A ==> E ENABLED FB
3A ==> E ENABLED 0C
4A ==> D DISABLED 11
5A ==> D DISABLED FC
6A ==> E ENABLED FD
7A - -
8A - -

- TYPE E OR D TO CHANGE THE ENABLE/DISABLE REQUEST, THEN PRESS SEND
==>

F1:END      F3:ALARM      F5:UPDATE
    
```

1. Press:  until the cursor is at the appropriate **CHANGE E/D REQ** field.
2. Do you want to enable the channel adapter?
  - For yes, type **E**.
  - For no, type **D**.
3. Repeat the same steps if there are several channel adapters to update.
4. Press . The **E/D REQUEST** field displays new information immediately.

**Note:** If there are three asterisks in the **E/D REQUEST** column, the MOSS could not save or retrieve information because of a disk error. Issue the request again by entering either **E** or **D**.

If you still have the three asterisks, contact the person in charge of 3745 problem analysis (see page 1-5).

If a channel adapter is initialized, the **INTERFACE STATUS** field displays new information immediately. Otherwise, it is updated at the next IPL.

## Step 10

1. Press **Function** repeatedly until **0** is displayed.
2. Press **Validate**.
3. Go to Step 11.

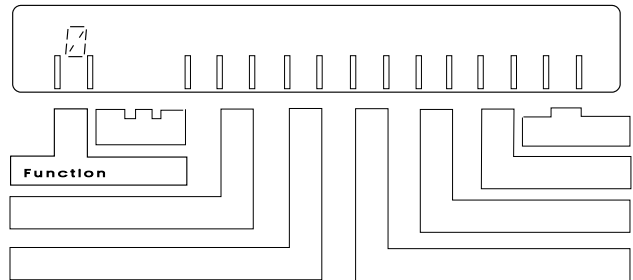

## Step 11

Do you want to set the 3745 to automatic host power <b>ON</b> ?	
<b>Yes</b>	<ol style="list-style-type: none"> <li>1. Press <b>Power Control</b> repeatedly until <b>1</b> displays.</li> <li>2. Press <b>Validate</b>.</li> <li>3. The procedure is finished.</li> </ol>
<b>No</b>	Go to Step 12.

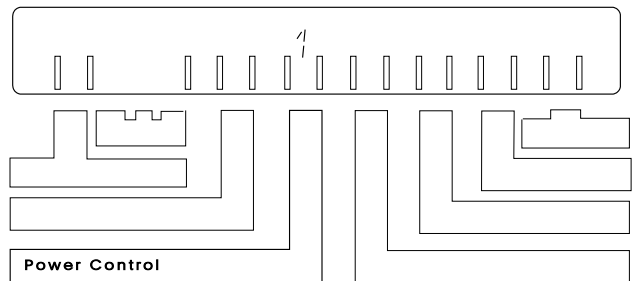

## Step 12

To power on at a scheduled time, follow these steps:

1. Press **Power Control** repeatedly until **2** displays.
2. Press **Validate**.
3. Use the MOSS 'Time Services' (TIM) function to enter appropriate scheduled power on data.

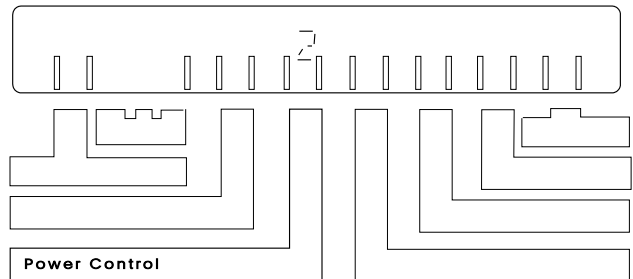



## Chapter 8. 3745 IPL from Service Processor

If you want to set an automatic IPL that follows a manual or automatic power ON, see Chapter 7, "3745 Power ON and IPL from Control Panel."

### Step 1

Open a MOSS window on the service processor (see page 3-10).

### Step 2

Type **IPL**.

### Step 3

Are you using a twin-CCU 3745 (Model 41A or 61A)?	
<b>Yes</b>	Go to Step 4.
<b>No</b>	<ol style="list-style-type: none"> <li>When the screen shown on the right displays, type <b>1</b> and press .</li> <li>When the IPL starts, go to Step 6.</li> </ol>

```

COMM CTRL ID:xxxxxxx      3745-XXX      SERIAL NUMBER:nnnnnn
CCU-A

----- mm/dd/yy hh:mm
FUNCTION ON SCREEN: IPL CCU(S)

- SELECT AN IPL OPTION (1, 2) ==>

  1 = NORMAL
  2 = STEP-BY-STEP

==>
F1:END  F2:MENU2  F3:ALARM
  
```

### Step 4

Do you want an IPL for all available CCUs?		
<b>Yes</b>	<ol style="list-style-type: none"> <li>Type <b>1</b> to IPL the active CCU.</li> <li>Go to Step 5.</li> </ol>	
<b>No</b>	Do you want to IPL only CCU A?	
	<b>Yes</b>	<ol style="list-style-type: none"> <li>Type <b>2</b>.</li> <li>Go to Step 5.</li> </ol>
	<b>No</b>	<ol style="list-style-type: none"> <li>Type <b>3</b> to IPL CCU B.</li> <li>Go to Step 5.</li> </ol>

```

-----
FUNCTION ON SCREEN: IPL CCU(S)

- SELECT THE CCU YOU WANT TO IPL (1 TO 3) ==> 1

  1 = AVAILABLE CCU(S) ACCORDING TO OPERATING MODE
  2 = CCU-A
  3 = CCU-B

- SELECT AN IPL OPTION (1, 2) ==>

  1 = NORMAL
  2 = STEP-BY-STEP

==>
F1:END  F2:MENU2
  
```

### Step 5

Type **1** and press  to select a normal IPL option.

## Step 6

When the IPL starts, the screen at the right displays. →

Will the control program be loaded from a fixed disk?	
<b>Yes</b>	Go to Step 7.
<b>No</b>	<ol style="list-style-type: none"> <li>1. Wait for the message ENABLED CA (see the example on the right →). Ask the network operator to load the control program (this message is explained on 8-4).</li> <li>2. Go to Step 7.</li> </ol>

```

COMMCTAL ID: IBM La Gaudé          3745-61A          SERIAL NUMBER:
CCU-A          PROCESS MOSS-OFFLINE
RUN           BYP-IOC-CHK STOP-CCU-CHK
IPL CCU-A PHASE 3  ENABLED CA YN----- L -----
CCU-B          PROCESS MOSS-OFFLINE
RUN           BYP-IOC-CHK STOP-CCU-CHK
IPL CCU-B PHASE 3  ENABLED CA ----Y----- L -----
FUNCTION ON SCREEN: IPL CCU(S)
                    CCU AND SCANNER IPL

                    WHEN THIS FUNCTION IS COMPLETE (SEE ABOVE), PRESS F1

===>

F1:END  F2:MENU2          F4:STOP  F5:RESUME
  
```

```



COMMCTAL ID: IBM La Gaudé          3745-61A          SERIAL NUMBER:
CCU-A          PROCESS MOSS-OFFLINE
RUN           BYP-IOC-CHK STOP-CCU-CHK
IPL CCU-A PHASE 3  ENABLED CA YN----- L -----
CCU-B          PROCESS MOSS-OFFLINE
RUN           BYP-IOC-CHK STOP-CCU-CHK
IPL CCU-B PHASE 3  ENABLED CA ----Y----- L -----
FUNCTION ON SCREEN: IPL CCU(S)
                    CCU AND SCANNER IPL

                    WHEN THIS FUNCTION IS COMPLETE (SEE ABOVE), PRESS F1

===>

F1:END  F2:MENU2          F4:STOP  F5:RESUME
  
```

## Step 7

Are you using a dual-CCU 3745?	
<b>Yes</b>	<p>Wait for the message IPL COMPLETE to display on both CCUs.</p> <p>In twin standby mode, the standby CCU is automatically pre-loaded with the active load module.</p> <p>Press  to end the procedure.</p> <p>See page 8-6 for an explanation of messages in <b>A</b> field.</p>
<b>No</b>	<p>When you see the message IPL COMPLETE, press  to end the procedure.</p> <p>See page 8-6 for an explanation of messages in <b>A</b> field.</p>

```

COMM CTRL ID:xxxxxxx      3745-XXX      SERIAL NUMBER:nnnnnn
IPL CCU-A      A      IPL COMPLETE
IPL CCU-B      A      IPL COMPLETE

FUNCTION ON SCREEN: IPL CCU(S)
                   CCU AND SCANNER IPL

                WHEN THIS FUNCTION IS COMPLETE (SEE ABOVE), PRESS F1

====>
F1:END  F2:MENU2  F3:ALARM  F4:STOP  F5:RESUME
  
```

For dual-CCU models.

```

COMM CTRL ID:xxxxxxx      3745-XXX      SERIAL NUMBER:nnnnnn
CCU-A
RUN
IPL CCU-A      A      IPL COMPLETE
                                     mm/dd/yy hh:mm

FUNCTION ON SCREEN: IPL CCU(S)
                   CCU AND SCANNER IPL

                WHEN THIS FUNCTION IS COMPLETE (SEE ABOVE). PRESS F1

====>
F1:END  F2:MENU2  F3:ALARM  F4:STOP  F5:RESUME
  
```

For single-CCU models.

---

## Power Supply of CA or IPL Port

The message ENABLED CA ----- L ----- indicates the status of channel adapters (CA) and link IPL ports (L). The single letter codes indicate the following:

**Y** for enabled.

**N** for disabled.

**U** for unusable (see procedure below).

- for not installed (for channel adaptors) or not defined (for link IPL ports).

The position of the letters shows the channel adapter and link IPL port number. For example, the following means that channels 1 and 2 are enabled:

```
ENABLED CA YYNNNNNNNNNNNNNN L NNNNNNNN
```

## Troubleshooting Channel Adapters and IPL Ports

If a **U** is displayed (meaning unusable), check the power supply to the CA or IPL port. If the problem persists, see the following procedure:

### Step 1

Note the position number of any CAs or IPL ports marked **U**.

```
■ COMMCTRL ID: IBH La Gaudle          3745-61A          SERIAL NUMBER:
CCU-A          PROCESS MOSS-OFFLINE
RUN           BYP-IOC-CHK STOP-CCU-CHK
IPL CCU-A PHASE 3  ENABLED CA YN----- L ----U--
CCU-B          PROCESS MOSS-OFFLINE
RUN           BYP-IOC-CHK STOP-CCU-CHK
IPL CCU-B PHASE 3  ENABLED CA ----U----- L -----
FUNCTION ON SCREEN: IPL CCU(S)
                    CCU AND SCANNER IPL

                    WHEN THIS FUNCTION IS COMPLETE (SEE ABOVE), PRESS F1

--->
F1:END  F2:MENU2          F4:STOP  F5:RESUME
```

### Step 2



Exit the IPL by pressing .

### Step 3

Type **POS** and press  to access the **Power Services** function.



## Step 4

Is the CA or IPL port located in the 3745 base frame?	
<b>Yes</b>	1. Type <b>1</b> and press  2. Go to Step 5.
<b>No</b>	The CA or IPL port is in the 3746-A11 unit. 1. Type <b>2</b> and press  2. Go to Step 5.

```

-----
FUNCTION ON SCREEN: POWER SERVICES

- SELECT ONE OPTION (1 TO 6, C, A OR D), THEN PRESS ENTR ==> .

1 = DISPLAY 3745                4 = DISPLAY 3746-L13
2 = DISPLAY 3746-A11           5 = DISPLAY 3746-L14
3 = DISPLAY 3746-A12           6 = DISPLAY 3746-L15

C = RE-CREATE POWER CONFIGURATION TABLE
A = AIR FILTERS / BATTERY CHANGE ACKNOWLEDGE
D = DISPLAY AIRFLOW DETECTOR STATUS

====>
F1:END

```

## Step 5

The MOSS screen on the right shows the CA or IPL link port adapter (LA) in the third and sixth **SUB-SYSTEM(S)** column.

Check the entry in the **STATUS** column on the same line. In the example shown on the right, CAs 1 and 2 are **DOWN**.

```

FUNCTION ON SCREEN: POWER SERVICES
POWER INFORMATION: 3745
PS ID   STATUS   SUBSYSTEM(S)  PS ID   STATUS   SUBSYSTEM(S)
1       UP       MOSS          5       UP       LH        1
2       UP       CCU A        9       UP       LA        3,4
3       UP       CCU B        10      UP       LA        5
4       DOWN      CA 1,2       11      UP       LA        7,8
-       -       -            12      UP       -
5       UP       CA 5         13      UP       -



- ENTER UXX OR CXX TO POWER-UP OR POWER-DOWN PS ID XX ==> .

====>
COMMAND SUCCESSFULLY PERFORMED

F1:END                F4:HELP                F5:QUIT

```

## Step 6

Is the CA or IPL port status <b>UP</b> ?	
<b>Yes</b>	Contact the person in charge of 3745 problem analysis (see page 1-5).
<b>No</b>	1. Type <b>uxx</b> for the <b>PS ID</b> . 2. Press  3. The status changes from <b>DOWN</b> to <b>UP</b> as shown in the example on the right. →
	<b>Yes</b> 1. Press  to exit the <b>POS</b> function. 2. Restart the IPL (see page 8-1).
	<b>No</b> If the power status remains <b>DOWN</b> , see "Solving Problems" on page 1-5.

```

----- 12/04/95
FUNCTION ON SCREEN: POWER SERVICES
POWER INFORMATION: 3745
PS ID   STATUS   SUBSYSTEM(S)  PS ID   STATUS   SUBSYSTEM(S)
1       UP       MOSS          8       UP       LA        1
2       UP       CCU A        9       UP       LA        3,4
3       UP       CCU B        10      UP       LA        5
4       UP       CA 1,2       11      UP       LA        7,8
-       -       -            12      UP       -
5       UP       CA 5         13      UP       -

- ENTER UXX OR CXX TO POWER-UP OR POWER-DOWN PS ID XX ==> .

====>
F1:END                F4:HELP                F5:QUIT

```

## Information Displayed on the MOSS Screen during IPL

Information on the IPL displays in the machine status area (MSA) of the MOSS screen as shown on the right. →

For a complete explanation on these messages, see *Advanced Operations Guide*, SA33-0097.

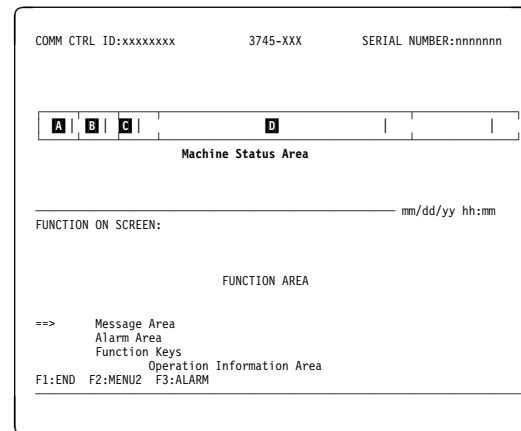

The following is a list of messages that you may see in the MSA during an IPL.

### Messages appearing in **A** :

**IPL**            3745 IPL has started.

### Messages appearing in **B** :

**PHASE 1**    CCU initialization.

**PHASE 2**    Control program loader in the CCU loaded and started.

**PHASE 3**    Scanner (line adapter) IML in progress.

**PHASE 4**    Scanners (line adapters) are IMLed.

### Messages appearing in **C** :

**STOP**        3745 IPL suspended because of a fallback or operator request.

**SUSPEND**   IPL of current CCU suspended while the IPL of the second CCU is initiated. The suspended IPL resumes when the second IPL has reached the same phase. Both IPLs then continue until complete.

### Messages appearing in **D** :

**CA IPL DETECTED ON CA x**

A control program load/dump is running on a channel-attached 3745. **x** is the channel adapter number. If this message displays for more than 5 minutes, contact the person in charge of 3745 problem analysis (see page 1-5).

**CONTROL PROGRAM LOADED**

The control program successfully loaded.

**CP SAVE ON DISK IN PROGRESS**

The control program is being saved onto disk. If this message remains for a long time, contact the person in charge of 3745 problem analysis (see page 1-5).

<b>DUMP IN PROGRESS ON CA x</b>	The control program for a channel-attached 3745 is being dumped ( <b>x</b> is the channel adapter number). Contact the person in charge of 3745 problem analysis (see page 1-5).
<b>DUMP IN PROGRESS ON L xxxx</b>	The control program for a link-attached 3745 is being dumped ( <b>xxxx</b> is the decimal communication line address). Contact the person in charge of 3745 problem analysis (see page 1-5).
<b>DUMP ON MOSS DISK IN PROGRESS</b>	The control program is being dumped on to disk. Contact the person in charge of 3745 problem analysis (see page 1-5).
<b>ENABLED CA ----- L -----</b>	Shows which channel adapters (CA) or link IPL ports (L) are enabled or disabled.  <b>Y</b> means enabled. <b>N</b> means disabled. <b>U</b> means unusable. - means not installed (for channel adaptors) or not defined (for link IPL ports).  The position of the letters gives the channel adapter and link IPL port number. For example, the message below means that only channel adapters 1 and 2 are enabled. ENABLED CA YYNNNNNNNNNNNNNN L NNNNNNNN  If a U is displayed, go to page 8-4 and check the power supply of the CA or IPL port in question.  For more information see page 8-4.
<b>FALLBACK CANCELED</b>	3745 fallback canceled. If you did not request this, contact the person in charge of 3745 problem analysis (see page 1-5).
<b>FALLBACK CHECK Fxx</b>	Contact the person in charge of 3745 problem analysis (see page 1-5).
<b>FALLBACK COMPLETE</b>	3745 fallback successfully completed.
<b>FALLBACK COMPLETE + ERRORS</b>	3745 fallback completed but with errors. Contact the person in charge of 3745 problem analysis (see page 1-5).
<b>FALLBACK IN PROGRESS</b>	3745 fallback in progress.
<b>IPL CANCELED</b>	3745 IPL canceled. If you did not request this, contact the person in charge of 3745 problem analysis (see page 1-5).
<b>IPL CHECK Fxx</b>	3745 IPL ends abnormally. Contact the person in charge of 3745 problem analysis (see page 1-5).
<b>IPL CHECK F1B CLDP ABEND xxxx</b>	3745 IPL ended abnormally. Contact the person in charge of 3745 problem analysis (see page 1-5).
<b>IPL COMPLETE</b>	3745 IPL successfully completed.
<b>IPL COMPLETE + ERRORS</b>	IPL completed, but with non-disruptive errors. Contact the person in charge of 3745 problem analysis (see page 1-5).
<b>IPL FROM MOSS DISK IN PROGRESS</b>	NCP loading from disk in progress.
<b>IPL IN PROGRESS</b>	3745 IPL in progress.

<b>LINK IPL DETECTED ON L xxxx</b>	A control program load/dump has started via a link-attached 3745. <b>xxxx</b> is the decimal communication line address. If this message remains, contact the person in charge of 3745 problem determination (see page 1-5).
<b>LINK TEST PROGRAM ABEND</b>	Contact the person in charge of 3745 problem analysis (see page 1-5).
<b>LINK TEST PROGRAM LOADED</b>	Link test program successfully loaded.
<b>LOAD FROM MOSS DISK IN PROGRESS</b>	Control program load onto the CCU from the MOSS disk.
<b>LOAD IN PROGRESS ON CA x</b>	Control program load onto a channel-attached 3745. <b>x</b> is the channel adapter number. If this message remains, contact the person in charge of 3745 problem determination (see page 1-5).
<b>LOAD IN PROGRESS ON L xxxx</b>	Control program load on a link-attached 3745. <b>xxxx</b> is the decimal communication line address. If this message remains, contact the person in charge of 3745 problem determination (see page 1-5).
<b>RPO DETECTED ON L xxxx</b>	A remote power OFF (RPO) command detected on a communication line <b>xxxx</b> ( <b>xxxx</b> is the decimal communication line address).
<b>SCANNER(S) NOT IMLED: xxxxxxxx</b>	Contact the person in charge of 3745 problem analysis (see page 1-5).
<b>SWITCHBACK CANCELED</b>	3745 switchback canceled. If you did not request this, contact the person in charge of 3745 problem analysis (see page 1-5).
<b>SWITCHBACK CHECK Fxx</b>	Contact the person in charge of 3745 problem analysis (see page 1-5).
<b>SWITCHBACK COMPLETE</b>	3745 switchback successfully completed.
<b>SWITCHBACK COMPLETE + ERRORS</b>	3745 switchback completed, but with errors. Contact the person in charge of 3745 problem analysis (see page 1-5).
<b>SWITCHBACK IN PROGRESS</b>	3745 switchback in progress.
<b>TEST CHECK Fxx</b>	Standby CCU test ended abnormally. Contact the person in charge of 3745 problem analysis (see page 1-5).
<b>TEST IN PROGRESS</b>	Standby CCU test in progress.
<b>TEST COMPLETE</b>	Standby CCU test successfully completed.
<b>TEST CANCELED</b>	Standby CCU test canceled on operator request.

# Chapter 9. 3745 Models 41A and 61A Fallback and Switchback

## Fallback

Open a MOSS window at the service processor (see page 3-10).

### Step 1

Type **FBK** and press .

### Step 2

Are you using twin-standby mode?	
<b>Yes</b>	Go to Step 3.
<b>No</b>	<p>1. Type <b>1</b> or <b>2</b> at <b>A</b> to select the CCU. Type <b>1</b> or <b>2</b> at <b>B</b>.</p> <p>If you enter <b>2</b>, wait until the message <b>ALARM B0</b> displays, indicating that the request has been sent.</p> <p>2. Press .</p> <p>3. Go to Step 4.</p>

```

COMM CTRL ID:xxxxxxx      3745-XXX      SERIAL NUMBER:nnnnnnn
-----
FUNCTION ON SCREEN: FALLBACK      mm/dd/yy hh:mm
- SELECT THE CCU THAT WILL SUPPORT THE WHOLE CONFIGURARTION (1,2) ==> A
  1 = CCU-A
  2 = CCU-B
- SELECT THE FALLBACK PHASE (1, 2) ==> B
  1 = REQUEST NETWORK OPERATOR TO DEACTIVATE LINES (IF NECESSARY)
  2 = PERFORM FALLBACK
- PLEASE CONFIRM YOUR SELECTION: Y OR N. THEN PRESS SEND ==>
==>
F1:END  F2:MENU2  F3:ALARM
  
```

Twin-backup

### Step 3

Type **1** or **2** at **B** then press  to start fallback.

If you enter **2**, wait until the message **ALARM B0** displays, indicating that the request has been sent.

```

COMM CTRL ID:xxxxxxx      3745-XXX      SERIAL NUMBER:nnnnnnn
-----
FUNCTION ON SCREEN: FALLBACK      mm/dd/yy hh:mm
- SELECT THE FALLBACK PHASE (1, 2) ==> B
  1 = REQUEST NETWORK OPERATOR TO DEACTIVATE LINES (IF NECESSARY)
  2 = PERFORM FALLBACK
==>
ALARM B0: HOST OPERATOR NOTIFIED: FALLBACK TO BE PERFORMED
F1:END  F2:MENU2  F3:ALARM
  
```

Twin-standby

## Step 4

Wait until the message PLEASE CONFIRM YOUR SELECTION displays.

Type **Y** and press  to begin fallback. The screen at the right displays. →

**Note:** You cannot cancel fallback once it starts.

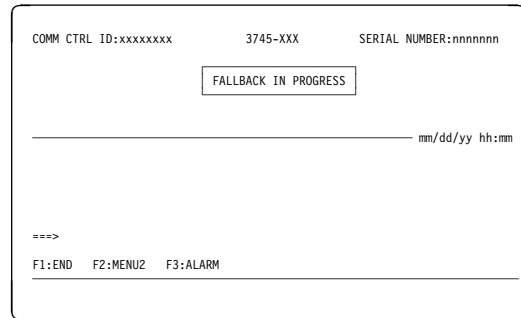

## Step 5

Wait until the message FALLBACK COMPLETE displays.

Press  to end the procedure.

For the meaning of messages displayed in **A** field, see page 8-6.

The message ALARM B1 indicates that fallback has completed.

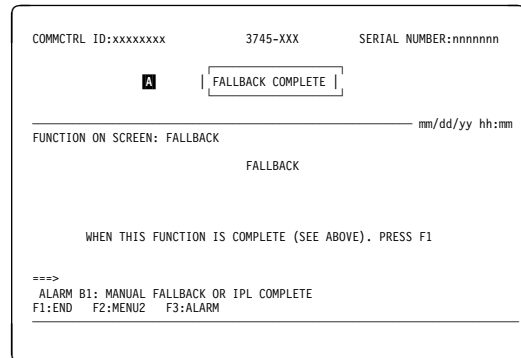

Are you using twin-standby mode?	
<b>Yes</b>	Go to Step 6.
<b>No</b>	<p>1. When fallback is complete, an automatic IPL is initiated on the first CCU.</p> <p><b>Note:</b> To re-start the CCU, use the <b>Switchback</b> function described on page 9-3.</p>

## Step 6

Is the control program pre-loaded on the standby CCU?	
<b>Yes</b>	An IPL automatically starts on the standby CCU. Go to Step 7.
<b>No</b>	When fallback is complete, an automatic IPL is initiated on the second CCU. The IPL ends with displaying the message TEST COMPLETE.  For the meaning of other messages that appear, see page 8-6.

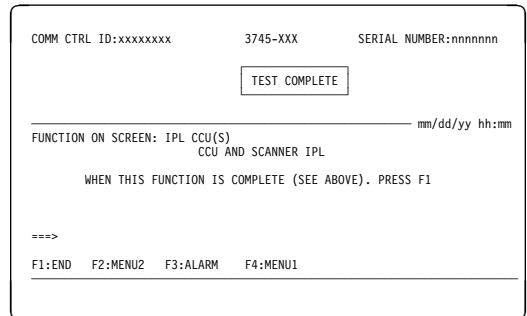

**Note:** Fallback needs to be performed again for the control program to be loaded on the CCU A channel or IPL link port.

## Step 7

Wait until you see the message  
IPL COMPLETE.

Pressing  ends the procedure.

For the meaning of other messages displayed in  field, see page 8-6.

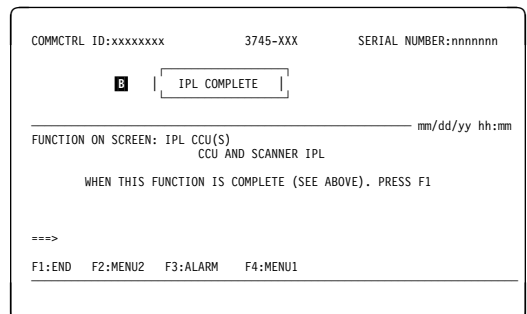

## Switchback

**Note:** Switchback can only be performed in twin-backup mode.

## Step 1

Make sure a MOSS window is open on the service processor (see page 3-10).

## Step 2

Type **SBK** and press  .

The screen at the right displays. →

```
CUSTOMER ID:xxxxxxx      3745-XXX      SERIAL NUMBER:nnnnnnn
_____ mm/dd/yy hh:mm
FUNCTION ON SCREEN: SWITCHBACK

- SELECT THE SWITCHBACK PHASE (1, 2) ==> A
  1 = REQUEST NETWORK OPERATOR TO DEACTIVATE LINES (IF NECESSARY)
  2 = PERFORM SWITCHBACK

==>>
ALARM B4: HOST OPERATOR NOTIFIED: SWITCHBACK TO BE PERFORMED
F1:END  F2:MENU2  F3:ALARM
```

## Step 3

Are the effected lines already deactivated?	
<b>Yes</b>	Go to Step 4.
<b>No</b>	<ol style="list-style-type: none"><li>1. Type <b>1</b> at <b>A</b> and press  . This is a request for the network operator to deactivate the lines. A message ALARM B4 indicates that the request has been sent.</li><li>2. When the lines are deactivated, go to Step 4.</li></ol>

## Step 4

Type **2** at **A** and press  (see the previous screen).



## Step 5

Does the message SWITCHBACK IN PROGRESS display?	
<b>Yes</b>	Go to Step 7.
<b>No</b>	Go to Step 6.

```





COMM CTRL ID:xxxxxxx      3745-XXX      SERIAL NUMBER:nnnnnn
      SWITCHBACK IN PROGRESS

mm/dd/yy hh:mm
FUNCTION ON SCREEN: SWITCHBACK

- SELECT THE SWITCHBACK PHASE (1, 2) ==>
  1 = REQUEST NETWORK OPERATOR TO DEACTIVATE LINES (IF NECESSARY)
  2 = PERFORM SWITCHBACK

==>
F1:END  F2:MENU2  F3:ALARM
  
```

## Step 6

The screen at the right shows that some resources are inactive. → Do you want to cancel switchback?	
<b>Yes</b>	<ol style="list-style-type: none"> <li>1. Type <b>C</b> and press .</li> <li>2. Type <b>Y</b> and press .</li> </ol> <p>This returns you to Step 2.</p>
<b>No</b>	<ol style="list-style-type: none"> <li>1. Send a request for the network operator to deactivate the resources on the screen.</li> <li>2. Type <b>C</b> and press .</li> <li>3. Type <b>Y</b> and press .</li> <li>4. Go to Step 7.</li> </ol>

```

COMM CTRL ID:xxxxxxx      3745-XXX      SERIAL NUMBER:nnnnnn
      SWITCHBACK IN PROGRESS

mm/dd/yy hh:mm
FUNCTION ON SCREEN: SWITCHBACK

WARNING:
SOME RESSOURCES ON THE CCU TO BE SWITCHED ARE NOT DEACTIVATED

NETWORK ADDRESS OF A LINE THAT IS NOT DEACTIVATED: XXXX
NOTIFY THE FOLLOWING HOST OPERATORS THAT THEY MUST FREE UP RESOURCES
XXXXXXXXXXXXXXXXXXXX XXXXXXXXXXXXXXXXXXXX XXXXXXXXXXXXXXXXXXXX XXXXXXXXXXXXXXXXXXXX
XXXXXXXXXXXXXXXXXXXX XXXXXXXXXXXXXXXXXXXX XXXXXXXXXXXXXXXXXXXX XXXXXXXXXXXXXXXXXXXX
XXXXXXXXXXXXXXXXXXXX XXXXXXXXXXXXXXXXXXXX XXXXXXXXXXXXXXXXXXXX XXXXXXXXXXXXXXXXXXXX
XXXXXXXXXXXXXXXXXXXX XXXXXXXXXXXXXXXXXXXX XXXXXXXXXXXXXXXXXXXX XXXXXXXXXXXXXXXXXXXX

CANCEL OR FORCE THE SWITCHBACK: C=CANCEL. F=FORCE ==>  A
- PLEASE CONFIRM YOUR SELECTION: Y OR N. THEN PRESS SEND ==>  B
==>
F1:END  F2:MENU2  F3:ALARM
  
```

**Note:** If you have a Model 41A or 61A, the warning message will be the following:

```

WARNING:
SOME RESOURCES ON THE CCU TO BE SWITCHED EITHER ARE NOT DEACTIVATED
OR CONTAIN AN ACTIVE TRANSMISSION GROUP

NETWORK ADDRESS OF A LINE THAT IS NOT DEACTIVATED: XXXX
NOTIFY THE FOLLOWING HOST OPERATORS THAT THEY MUST FREE UP RESOURCES
  
```

The procedure ends with the message ALARM B5: SWITCHBACK AND IPL COMPLETE.

For the meaning of other messages that display in this field, see 8-6.

The **Function Selection Rules** screen displays, and an automatic re-IPL of the original CCU begins.

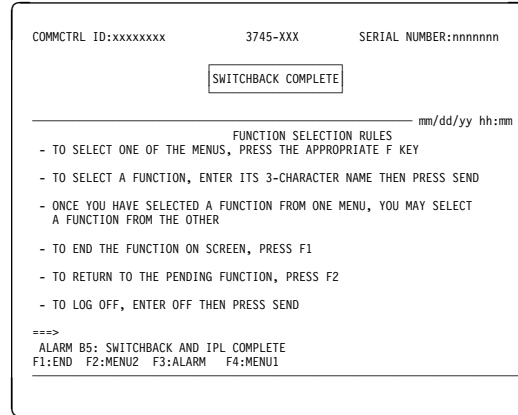

## Step 8

Does this message display?: IPL FROM MOSS DISK IN PROGRESS.					
<b>Yes</b>	Go to Step 9.				
<b>No</b>	If this message displays: ENABLED CA ...?				
	<table border="1"> <tr> <td><b>Yes</b></td> <td> <ol style="list-style-type: none"> <li>1. Ask the host operator to load the control program.</li> <li>2. Repeat this step again.</li> </ol> <p><b>Note:</b> For an explanation of this message, see page 8-4.</p> </td> </tr> <tr> <td><b>No</b></td> <td>Contact the person in charge of 3745 problem analysis (see page 1-5).</td> </tr> </table>	<b>Yes</b>	<ol style="list-style-type: none"> <li>1. Ask the host operator to load the control program.</li> <li>2. Repeat this step again.</li> </ol> <p><b>Note:</b> For an explanation of this message, see page 8-4.</p>	<b>No</b>	Contact the person in charge of 3745 problem analysis (see page 1-5).
	<b>Yes</b>	<ol style="list-style-type: none"> <li>1. Ask the host operator to load the control program.</li> <li>2. Repeat this step again.</li> </ol> <p><b>Note:</b> For an explanation of this message, see page 8-4.</p>			
<b>No</b>	Contact the person in charge of 3745 problem analysis (see page 1-5).				

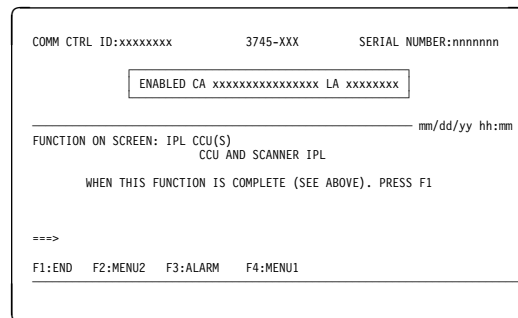
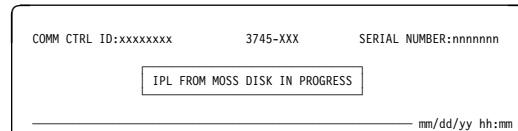

## Step 9

Wait for the message IPL COMPLETE to display.

For the meaning of other messages that display in **A** field, see page 8-6.

```
COMMCTRL ID:xxxxxxx          3745-XXX          SERIAL NUMBER:nnnnnn  
  
      A | IPL COMPLETE |  
  
----- mm/dd/yy hh:mm  
                FUNCTION SELECTION RULES  
- TO SELECT ONE OF THE MENUS, PRESS THE APPROPRIATE F KEY  
- TO SELECT A FUNCTION, ENTER ITS 3-CHARACTER NAME THEN PRESS SEND  
- ONCE YOU HAVE SELECTED A FUNCTION FROM ONE MENU, YOU MAY SELECT  
  A FUNCTION FROM THE OTHER  
- TO END THE FUNCTION ON SCREEN, PRESS F1  
- TO RETURN TO THE PENDING FUNCTION, PRESS F2  
- TO LOG OFF, ENTER OFF THEN PRESS SEND  
  
==>  
F1:END  F2:MENU2  F3:ALARM  F4:MENU1
```



## Chapter 10. Enabling and Disabling Channel Adapters

To enable or disable 3745 channel adapters, the following must apply:

- The channel adapter must be physically connected to the host.
- Switching units between the host and the 3745 must be correctly configured.
- A control program must be running in the CCU.

Enable or disable requests are saved on disk, and automatically retransmitted during an IML after power off.

### Enabling and Disabling 3745 Channel Adapters

Before you begin, make sure that you have a MOSS window open on the service processor (see page 3-10).

- Step 1.** If the **CA INTERF DISPLAY** screen below is not displayed, type **CID** on the command line and press .

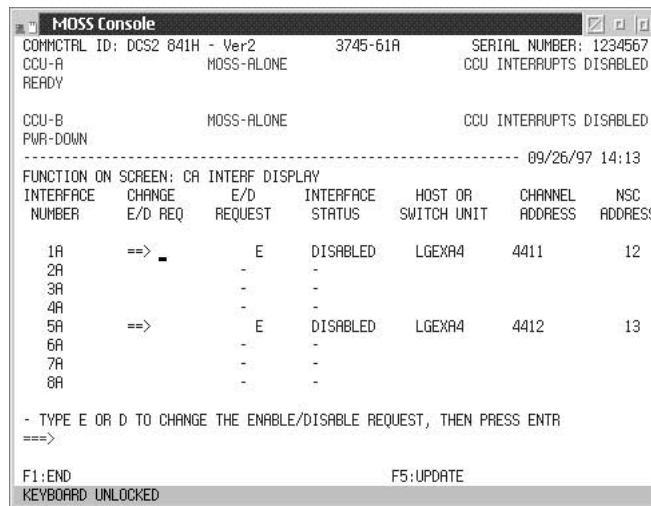

```
MOSS Console
COMMCTAL ID: DCS2 841H - Ver2      3745-61A      SERIAL NUMBER: 1234567
CCU-A      MOSS-ALONE      CCU INTERRUPTS DISABLED
READY

CCU-B      MOSS-ALONE      CCU INTERRUPTS DISABLED
PMR-DOWN

----- 09/26/97 14:13 -----
FUNCTION ON SCREEN: CA INTERF DISPLAY
INTERFACE CHANGE E/D INTERFACE HOST OR CHANNEL NSC
NUMBER    E/D REQ REQUEST STATUS SWITCH UNIT ADDRESS ADDRESS
-----
1A      ==> -      E      DISABLED  LGEXA4   4411     12
2A      -
3A      -
4A      -
5A      ==>      E      DISABLED  LGEXA4   4412     13
6A      -
7A      -
8A      -

- TYPE E OR D TO CHANGE THE ENABLE/DISABLE REQUEST, THEN PRESS ENTR
==>>

F1:END      F5:UPDATE
KEYBOARD UNLOCKED
```

- Step 2.** Press  until the cursor is in the appropriate **CHANGE E/D REQ** field.

- Step 3.** Enable or disable the channel adapter(s) by typing:

**E** to enable.

**D** to disable.

- Step 4.** Repeat the procedure if there are several channel adapters to update.

- Step 5.** Press  to update the **E/D REQUEST** column.

**Note:** Three asterisks in the **E/D REQUEST** column indicate that the MOSS could not save or retrieve information because of a disk error. Issue the request again, by entering either **E** or **D**.

If this does not work, contact the person in charge of 3745 problem analysis (see page 1-5).

The **INTERFACE STATUS** field shows new information when the channel adapter is initialized, or during the next IPL.

**Step 6.** Press  to end the procedure.

---

## Enabling and Disabling 3746-900 ESCON Channel Adapters

### Verifying an ESCON Coupler Status

**Step 1.** Open a MOSS-E menu for the 3746-900 (see page 3-8).

**Step 2.** Click **Configuration Management**, then double-click **Manage ESCON Processors**.

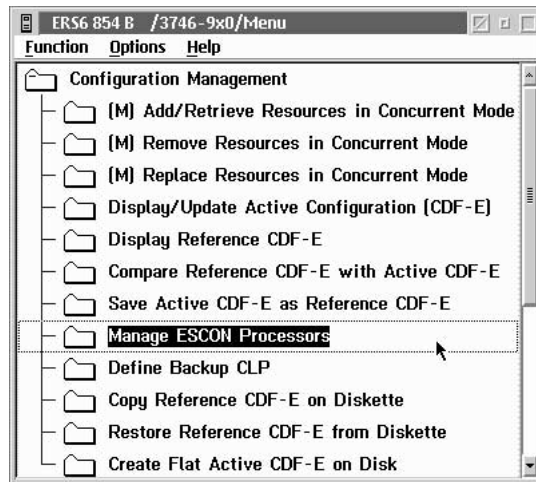

**Step 3.** Double-click the ESCON processor line (**ESCP**) to verify its status.

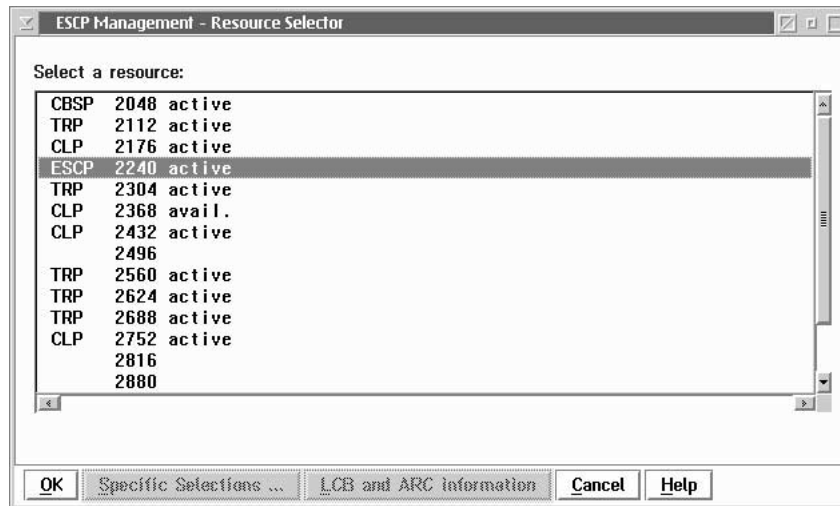

**Step 4.** Click **Options**, then **Manage ESCC status**.

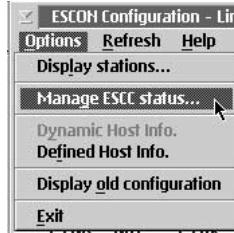

**Step 5.** A panel displays with status information about the coupler. To modify the status of the coupler, go to the next step. Otherwise, go to Step 10 on page 10-4.

**Step 6.** Select one of the following options:

- Enable**
- Transmit offline sequence**
- Disable.**

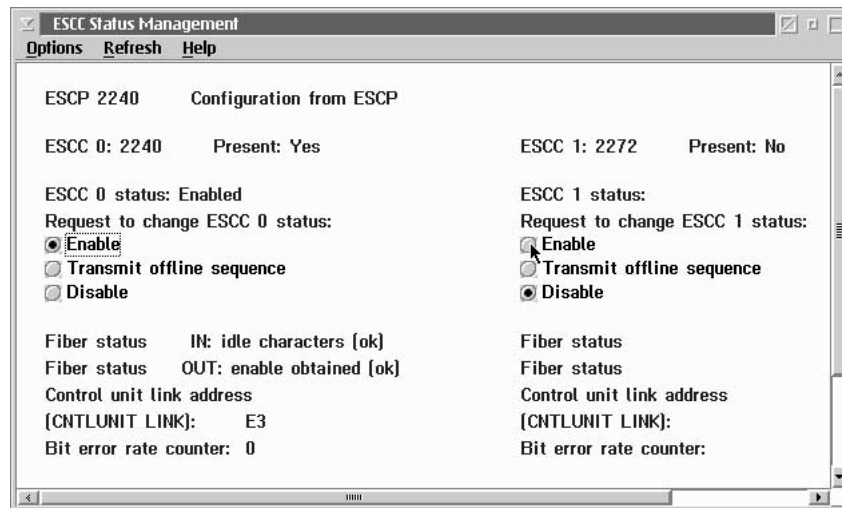

**Step 7.** Click **Options**, then **Send request**.

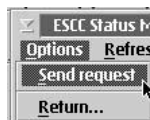

**Note:** If you want to save these options on the service processor hard disk, use CCM.

**Step 8.** Click **OK** on the next two screens.

**Step 9.** Click **Refresh**, then **One shot** to see the results.

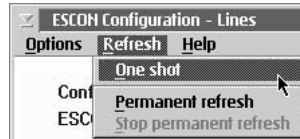

**Step 10.** Click **Options**, then **Return** to open the previous panel.

## Verifying a Link IPL Port

**Step 1.** Select an ESCP (see Step 3 on page 10-2).

**Step 2.** Click **Options**, then **Display stations**.



**Step 3.** Verify IPL port information for the station that you want.

**Note:** If you want to modify the IPL port information, use CCM.

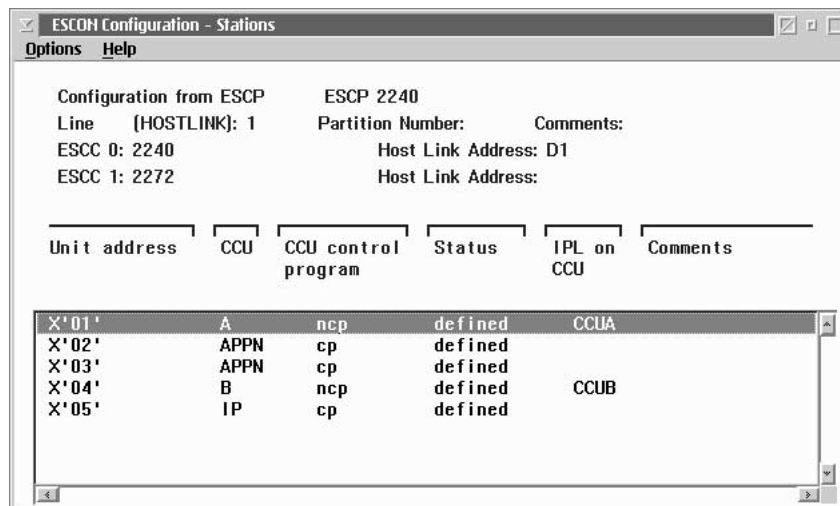



---

# Chapter 11. Basic Service Procedures

---

## 3745 MOSS IML from the Service Processor

Before you begin, make sure that you have a MOSS window open on the service processor (see page 3-10).

### Step 1

Type **IML** then press .

The screen on the right displays. →

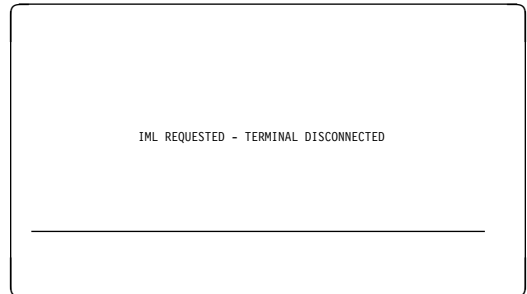

1. Wait until **MOSS-E View** displays.  
IML is complete when the 3745 icon turns pink in color.
2. Double-click **MOSS Console** in the MOSS-E 3745 menu.
3. Enter the three letter code of the MOSS function you want to use.

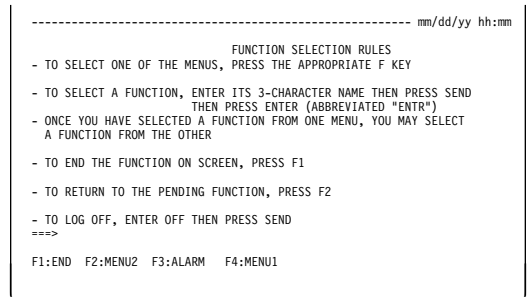

# 3745 Scanner (Line Adapter) IML







## Step 1

Make sure a MOSS window is open on the service processor (see page 3-10).

The screen on the lower right displays.

## Step 2

**A** or **B** on the screen shows the MOSS status of the CCU, attached to a scanner.

Is the MOSS online?					
<b>Yes</b>	Go to Step 3.				
<b>No</b>	Is the MOSS off-line?				
	<table border="1"> <tr> <td><b>Yes</b></td> <td>           1. Type <b>CSR</b>, then <b>1</b>, or <b>2</b> to select a CCU, then press .            2. Type <b>MON</b> and press  to bring the MOSS online.            3. Go to Step 3.         </td> </tr> <tr> <td><b>No</b></td> <td>           1. Load the control program on to the CCU by performing an IPL (see Chapter 8, "3745 IPL from Service Processor" on page 8-1). Then go to the next step.         </td> </tr> </table>	<b>Yes</b>	1. Type <b>CSR</b> , then <b>1</b> , or <b>2</b> to select a CCU, then press  . 2. Type <b>MON</b> and press  to bring the MOSS online. 3. Go to Step 3.	<b>No</b>	1. Load the control program on to the CCU by performing an IPL (see Chapter 8, "3745 IPL from Service Processor" on page 8-1). Then go to the next step.
	<b>Yes</b>	1. Type <b>CSR</b> , then <b>1</b> , or <b>2</b> to select a CCU, then press  . 2. Type <b>MON</b> and press  to bring the MOSS online. 3. Go to Step 3.			
<b>No</b>	1. Load the control program on to the CCU by performing an IPL (see Chapter 8, "3745 IPL from Service Processor" on page 8-1). Then go to the next step.				

```

COMM CTRL ID:xxxxxxx          3745-XXX          SERIAL NUMBER:nnnnnn
CCU-A          PROCESS MOSS-ONLINE A
RUN

CCU-B          PROCESS MOSS-OFFLINE B
RUN
_____ mm/dd/yy hh:mm

          FUNCTION SELECTION RULES
- TO SELECT ONE OF THE MENUS, PRESS THE APPROPRIATE F KEY
- TO SELECT A FUNCTION, ENTER ITS 3-CHARACTER NAME THEN PRESS SEND
  THEN PRESS ENTER (ABBREVIATED "ENTR")
- ONCE YOU HAVE SELECTED A FUNCTION FROM ONE MENU, YOU MAY SELECT
  A FUNCTION FROM THE OTHER
- TO END THE FUNCTION ON SCREEN, PRESS F1
- TO RETURN TO THE PENDING FUNCTION, PRESS F2
- TO LOG OFF, ENTER OFF THEN PRESS SEND
==>

F1:END  F2:MENU2  F3:ALARM  F4:MENU1  F5:MENU3
  
```

## Step 3

To IML a scanner, type **IMS** and press



The screen on the right displays. →

```
COMM CTRL ID:xxxxxxx      3745-XXX      SERIAL NUMBER:nnnnnn
CCU-A      PROCESS MOSS-ONLINE
RUN

CCU-B      PROCESS MOSS-OFFLINE
RUN

FUNCTION ON SCREEN: IML ONE SCANNER

- ENTER:

  THE SCANNER NUMBER PRECEDED BY S (S1 TO S32)
  OR
  THE LINE ADDRESS (000 TO 1071)
  (0 TO 895 FOR TSS )
  (1024 TO 1039 FOR HPTSS)
  (1056 TO 1071 FOR ESS )

==>

F1:END F2:MENU2 F3:ALARM
```

## Step 4

1. Enter either the scanner (line adapter) number or the address of a line attached to the scanner at **A**.
2. Type **SX** or **SY** and press  (where **X** equals the scanner number, and **Y** equals the line address).

The IML begins when the following message displays:

IML FOR SCANNER xx IN PROGRESS.

If the message **INVALID INPUT** displays, restart this step.

If the following message displays:  
**SCANNER CANNOT BE IMLED: MOSS IS NOT ONLINE**, set the **MOSS** online by performing Step 2.

If any other messages display, contact the person in charge of 3745 problem analysis (see page 1-5).

```
COMM CTRL ID:xxxxxxx      3745-XXX      SERIAL NUMBER:nnnnnn
CCU-A      PROCESS MOSS-ONLINE
RUN

CCU-B      PROCESS MOSS-OFFLINE
RUN

FUNCTION ON SCREEN: IML ONE SCANNER

- ENTER:

  THE SCANNER NUMBER PRECEDED BY S (S1 TO S32)
  OR
  THE LINE ADDRESS (000 TO 1071)
  (0 TO 895 FOR TSS )
  (1024 TO 1039 FOR HPTSS)
  (1056 TO 1071 FOR ESS )

==> A

==> IML FOR SCANNER xx IN PROGRESS

F1:END F2:MENU2 F3:ALARM
```

## Step 5

Wait approximately one minute. If the IML is successful, the following message displays:

IML FOR SCANNER xx COMPLETED:  
SCANNER IS CONNECTED. →

```

COMM CTRL ID:xxxxxxx      3745-XXX      SERIAL NUMBER:nnnnnn
CCU-A      PROCESS MOSS-ONLINE
RUN
CCU-B      PROCESS MOSS-OFFLINE
RUN
FUNCTION ON SCREEN: IML ONE SCANNER      mm/dd/yy hh:mm

- ENTER:

  THE SCANNER NUMBER PRECEDED BY S (S1 TO S32)
  OR
  THE LINE ADDRESS (000 TO 1071)
  (0 TO 895 FOR TSS )
  (1024 TO 1039 FOR HPTSS)
  (1056 TO 1071 FOR ESS )

==> IML FOR SCANNER xx COMPLETED: SCANNER IS CONNECTED

F1:END F2:MENU2 F3:ALARM
  
```

## Step 6

Press  to end the procedure.

---

## MOSS IML from the 3745 Control Panel

If you have a problem with this step, see the online *Problem Analysis Guide*.

### Step 1

Is <b>Service Mode</b> set to <b>0</b> ?	
<b>Yes</b>	Go to Step 2.
<b>No</b>	<ol style="list-style-type: none"> <li>1. Press <b>Service Mode</b> repeatedly until <b>0</b> displays.</li> <li>2. Press <b>Validate</b>.</li> <li>3. Go to step 2.</li> </ol>

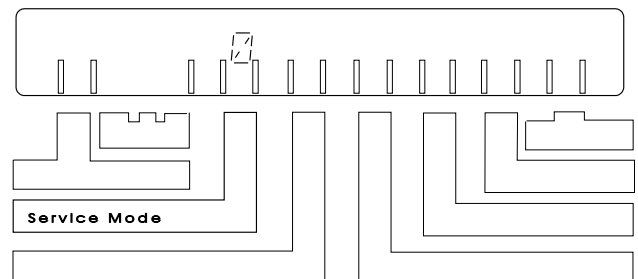

## Step 2

Is the <b>Power Control</b> set to <b>3</b> ?	
<b>Yes</b>	Go to Step 3.
<b>No</b>	<ol style="list-style-type: none"> <li>1. Note the <b>Power Control</b> setting; you will need to reset it at the end of this procedure.</li> <li>2. Press <b>Power Control</b> repeatedly until <b>3</b> displays.</li> <li>3. Press <b>Validate</b> and go to Step 3.</li> </ol>

### Note

**Power Control 3** (local mode) is intended for service procedures and is not recommended for normal operations. If the controller is left in local mode and there is a power failure, you will have to manually power ON.

Also, if there is a power failure, the power control must be set to **1** (remote mode) for the 3746 to automatically re-start.

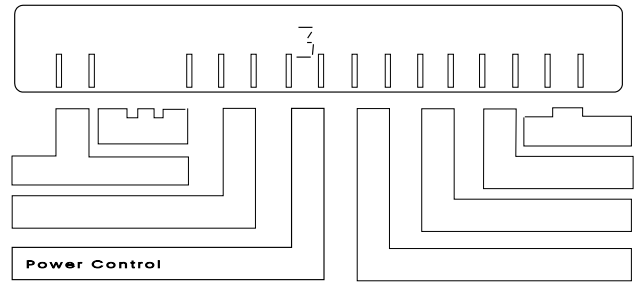

## Step 3

Is <b>Function</b> set to <b>1</b> ?	
<b>Yes</b>	Go to Step 4.
<b>No</b>	<ol style="list-style-type: none"> <li>1. Press <b>Function</b> repeatedly until <b>1</b> displays.</li> <li>2. Go to Step 4.</li> </ol>

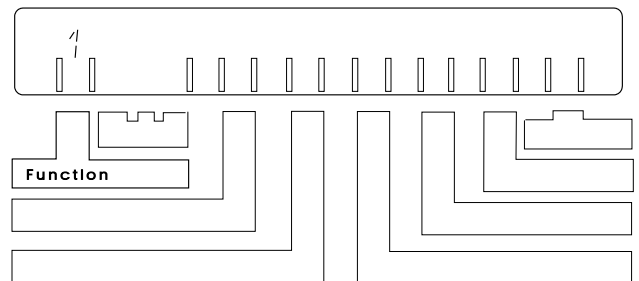

## Step 4

Press **Validate**.

The MOSS IML begins. You can see the progress of the IML on the hex display.

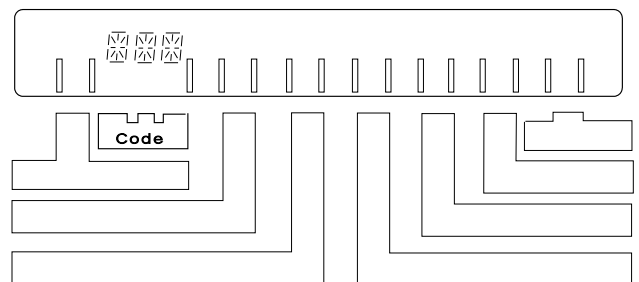

## Step 5

Wait for about 3 minutes until you see one of the following on the display:

- F0E indicating the MOSS, without NCP loaded.
- F0F indicating that the MOSS is offline, or that the IPL has completed in diskette mode.

To change the status of the MOSS, refer to the *Advanced Operations Guide*, SA33-0097.

For information on other codes that display, see page A-9.

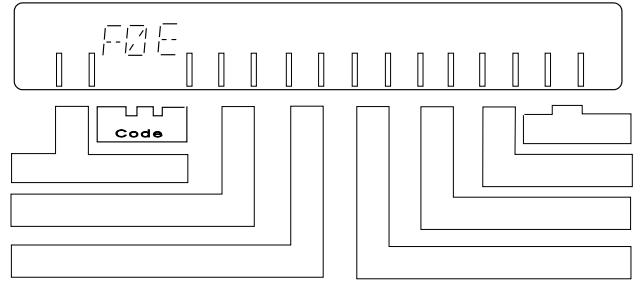

---

## 3746 Power State

When the main switch is on and connected to the main power supply, the 3746 has two power states (this applies to the entire 3745/3746 family). The power state can be either:

- Activated (IML complete, ready to work).
- Deactivated (only the main power box and the operator control panel are active).

## Power Control Mode Switching

This section describes changing from one power mode to the other (whether the 3746 is activated or de-activated).

To switch between local and remote mode from the control panel, perform the following:

- Step 1.** Press **Power Control** repeatedly until a **1** or a **3** displays, blinking. (**1** means remote and **3** means local.)

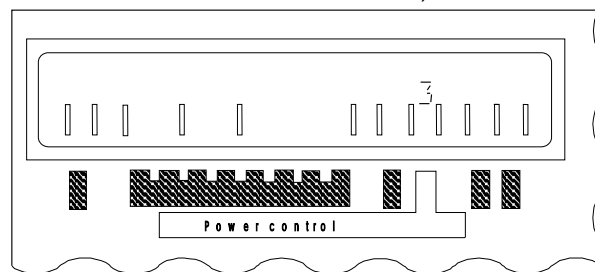

- Step 2.** Press **Validate**.

### Notes:

You can activate or deactivate the 3746 from the control panel when it is in **local** mode (see "Activation and IML from the 3746 Operator Control Panel" on page 11-10).

The power state of the 3746 in **remote** mode depends on external power commands received from the following:

- 3745 base frame.
- Service Processor (see “Activation/Deactivation from the Service Processor”).
- Host via the External Power On (EPO) cable (see “Activation/Deactivation from a Host” on page 11-9).

Any one of the above sending a power ON command will activate the 3746.

Any one of the above sending a power OFF command will de-activate the 3746.

## Switching from Remote to Local (1 to 3)

The power state does not change.

## Switching from Local to Remote (3 to 1)

The power state depends on the initial settings of the 3746, and any pending power commands.

The 3746 is activated if the following applies:

- The 3745 is powered ON.
- A power ON command is pending from a connected host.

Otherwise, the 3746 remains deactivated.

The 3746 is deactivated if the following applies:

- The 3745 is powered OFF.
- No power ON command pending from a connected host.
- No power ON command pending from the service processor.

Otherwise, the 3746 remains active.

---

## Activation/Deactivation from the Service Processor

Before activating or de-activating the 3746 from the service processor, make sure the Power Control is set to **1 (Remote)** mode. If necessary, change the power control setting as follows:

**Step 1.** Press **Power Control** repeatedly until **1** blinks.

**Step 2.** Press **Validate**.

## Activation

Before activating the 3746, make sure the **Standby** light on the control panel is ON.

**Step 1.** Open a MOSS-E menu to activate the 3746 (see to “MOSS-E Menus, Tasks, and Functions” on page 3-8).

**Step 2.** Click **Operation Management**.

**Step 3.** Double-click **Manage MOSS-E/3746-9x0 Power Dependency**.

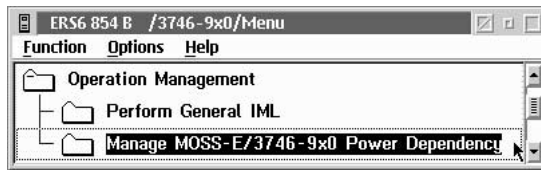

**Step 4.** Click **Set Power Dependency** and click **OK**.

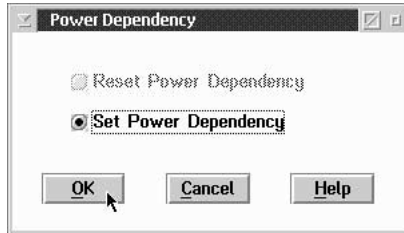

The 3746 is activated. If there are errors, see the **Display Alarms** function, or the online help for more information.

## Deactivation

Before de-activating the 3746-900, make sure the Ready light is ON, but not blinking.

**Step 1.** Open a MOSS-E menu to de-activate the 3746 (see "MOSS-E Menus, Tasks, and Functions" on page 3-8).

**Step 2.** Click **Operation Management**.

**Step 3.** Double-click **Manage MOSS-E/3746-9x0 Power Dependency**.

**Step 4.** Click **Reset power dependency**.

**Step 5.** Click **OK**.

The 3746 remains active if any of the following applies:

- Activation locally or from a network mode.
- Power ON request from a connected host.
- 3745 is powered ON.

The 3746 is deactivated if any of the following applies:

- 3745, 3746, and connected hosts powered OFF.

Attempt to activate the 3746 in remote mode when there is no power ON request from a connected host.

If there are errors, see the **Display Alarms** function, or online help for more information.



---

## Activation/Deactivation from a Host

This section describes the results of power ON/OFF commands from a host connected to the 3746 via the external power off (EPO) cable. Results may differ, depending on whether the power mode is local or remote.

### Power ON Command

Make sure the Standby light is ON, but not blinking.

When the host generates a Power ON command, the 3746 is inactivated in local mode, and activated in remote mode.

The Ready light blinks and stays ON.

If an error occurs, call the IBM representative (see “Solving Problems” on page 1-5).

### Power OFF Command

The Ready light must be ON, but not blinking.

When the host generates a Power OFF command, the following occurs:

- The 3746 stays active in local mode.
- In remote mode:
  - 3746 stays active if the following applies:
    - 3745 is powered ON.
    - Service processor requests activation (see “Activation” on page 11-7).
    - Power ON command is generated by another host connected to the 3746 via an EPO cable.
  - The 3746 is deactivated if the following applies:
    - 3745 is powered OFF.
    - Service processor requests deactivation (see “Deactivation” on page 11-8).
    - No power ON commands from other hosts connected to the 3746 via EPO cable.

The **Standby** light begins to blink and then goes ON.

If an error occurs, call the IBM representative (see “Solving Problems” on page 1-5).

### VTAM Remote Power OFF Command

A remote power OFF (RPO) command can be sent to a remote 3745 and attached 3746 from VTAM. The remote 3746 powers OFF only if the following applies:

- 3745 Power Control is in a network mode.
- 3746 Power Control is in remote mode.

---

## Activation and IML from the 3746 Operator Control Panel

**Note:** For more information about the 3746 control panel, see Appendix B, “3746 Operator Control Panel.”

To activate the 3746, use the following procedure:

### Step 1

Is the <b>Ready</b> light ON or blinking?	
<b>Yes</b>	Go to Step 4.
<b>No</b>	Go to Step 2.

### Step 2

Is the <b>Power Control</b> set to 3?	
<b>Yes</b>	Go to Step 3.
<b>No</b>	<ol style="list-style-type: none"><li>1. Press <b>Power Control</b> repeatedly until 3 is blinking.</li><li>2. Press <b>Validate</b> and go to Step 3.</li></ol>

#### Note

**Power Control 3** (local mode) is intended for service procedures and is not recommended for normal operations. If the controller is left in local mode and there is a power failure, you will have to manually power ON.

Also, if there is a power failure, the Power Control must be set to 1 (remote mode) for the 3746 to automatically re-start.

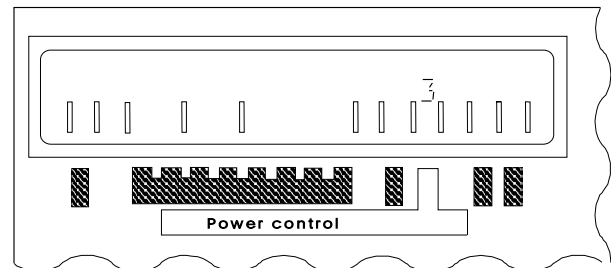

## Step 3

Do you want to do an IML with diagnostics?		
<b>Yes</b>	Does <b>Function</b> display 3?	
	<b>Yes</b>	Press <b>Validate</b> and go to Step 5.
	<b>No</b>	<ol style="list-style-type: none"> <li>1. Press <b>Function</b> repeatedly until <b>3</b> is blinking.</li> <li>2. Press <b>Validate</b>.</li> <li>3. Go to Step 5.</li> </ol>
<b>No</b>	Does <b>Function</b> display 8?	
	<b>Yes</b>	<ol style="list-style-type: none"> <li>1. Press <b>Validate</b>.</li> <li>2. Press <b>General IML</b>.</li> <li>3. Go to Step 5.</li> </ol>
	<b>No</b>	<ol style="list-style-type: none"> <li>1. Press <b>Function</b> repeatedly until <b>8</b> is blinking.</li> <li>2. Press <b>Validate</b>.</li> <li>3. Press <b>General IML</b>.</li> <li>4. Go to Step 5.</li> </ol>

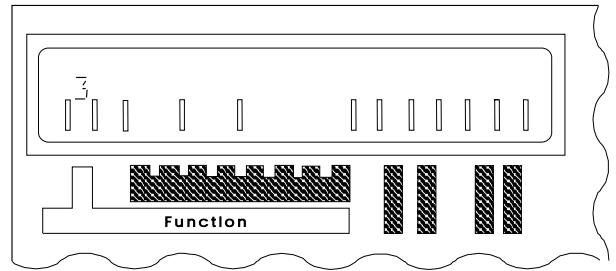

## Step 4

Do you want to do an IML with diagnostics?		
<b>Yes</b>	Does <b>Function</b> display 3?	
	<b>Yes</b>	<ol style="list-style-type: none"> <li>1. Press <b>Validate</b>.</li> <li>2. Go to Step 6.</li> </ol>
	<b>No</b>	<ol style="list-style-type: none"> <li>1. Press <b>Function</b> repeatedly until <b>3</b> is blinking.</li> <li>2. Press <b>Validate</b>.</li> <li>3. Go to Step 6.</li> </ol>
<b>No</b>	Does <b>Function</b> display 8?	
	<b>Yes</b>	<ol style="list-style-type: none"> <li>1. Press <b>Validate</b>.</li> <li>2. Press <b>General IML</b>.</li> <li>3. Go to Step 6.</li> </ol>
	<b>No</b>	<ol style="list-style-type: none"> <li>1. Press <b>Function</b> repeatedly until <b>8</b> is blinking.</li> <li>2. Press <b>Validate</b>.</li> <li>3. Press <b>General IML</b>.</li> <li>4. Go to Step 6.</li> </ol>

## Step 5

Wait until the hex code <b>05 28 2806</b> displays and the <b>Standby</b> light remains ON.	
<b>Yes</b>	<ol style="list-style-type: none"> <li>Press <b>Start</b> on the control panel. The 3746 activates and begins an IML. The <b>Ready</b> light starts blinking and the <b>Standby</b> light goes OFF.</li> <li>Go to Step 6.</li> </ol>
<b>No</b>	<ol style="list-style-type: none"> <li>Check the 3746 link with the MOSS-E. If * is not displayed in the <b>Service not accessible</b> field, see "Service Processor Inaccessible" on page B-5.</li> <li>Start again from Step 3.</li> <li>If the problem persists, refer to the progress codes in the online <i>Problem Analysis Guide</i>.</li> </ol>

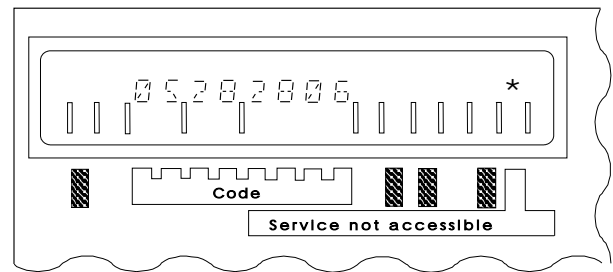

## Step 6

After a few minutes, check the following:		
<ul style="list-style-type: none"> <li>Is the hex code <b>00 00 0000</b> displaying?</li> <li>Is the <b>Ready</b> light remaining ON, without blinking?</li> </ul>		
<b>Yes</b>	IML is finished and the 3746 is ready for operation.	
<b>No</b>	Is there another code displaying and the <b>Ready</b> light blinking?	
	<b>Yes</b>	<ol style="list-style-type: none"> <li>Restart from Step 4.</li> <li>If the problem persists, see the progress codes in the online <i>Problem Analysis Guide</i>.</li> </ol>
	<b>No</b>	Contact the person in charge of 3746 problem analysis, (see page 1-5).

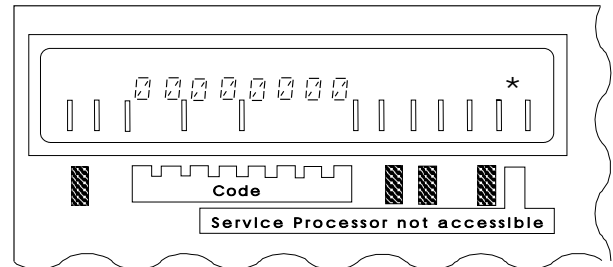

## Deactivation from the 3746 Operator Control Panel

To deactivate the 3746 from the control panel, use the following procedure:

### Step 1

Is <b>Power Control</b> set to 3?	
<b>Yes</b>	Go to Step 2.
<b>No</b>	<ol style="list-style-type: none"><li>1. Press <b>Power Control</b> repeatedly until <b>3</b> is blinking.</li><li>2. Press <b>Validate</b>.</li><li>3. Go to Step 2.</li></ol>

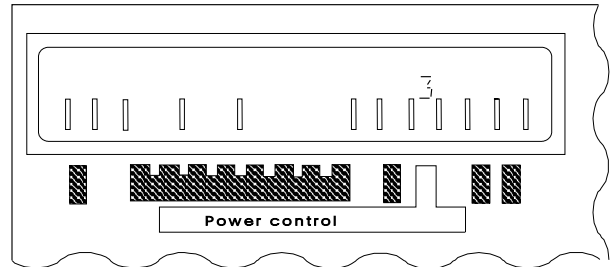

#### Note

**Power Control 3** (local mode) is intended for service procedures and is not recommended for normal operations. If the controller is left in local mode and there is a power failure, you will have to manually power ON.

Also, if there is a power failure, the power control must be set to **1** (remote mode) for the 3746 to automatically re-start.

### Step 2

Press **Standby**. After a few seconds, the **Ready** light changes from ON to OFF, and the **Standby** light blinks and then goes ON.

---

## Auto-Restart after a Power Failure

The 3746 automatically powers ON and performs an IML (the same as the 3745).

If there is a total power failure, the 3746 goes into standby mode. When power is restored, the 3746 automatically performs an IML. However, IML is only automatic if the following applies:

If a power failure occurs while the 3746 is activated:

- 3746 goes into power OFF state.
- When power is restored, the 3746 goes on standby and continues to perform an IML up to the ready state, and the following applies:
  - 3745 is powered ON.
  - Power ON commands are pending from a host attached to the 3746 via EPO cable.
  - The 3746 is activated by the power dependency function (see “Activation” on page 11-7).

If the power failure occurs while the machine is on standby:

- The machine goes into power OFF state.
- When power is restored, the 3746 returns to standby status until:
  - Power ON command is received from a host attached to the 3746 via EPO cable.
  - Power ON command is received from the service processor.
  - 3745 is powered ON.

# Appendix A. 3745 Operator Control Panel

## Notes:

The control panel display should not appear as totally blank. If it is, or if you suspect a problem on the control panel, contact the person in charge of 3745 problem analysis (see page 1-5).

Take a moment to review the reference card in the diskette storage compartment to the left of the control panel.

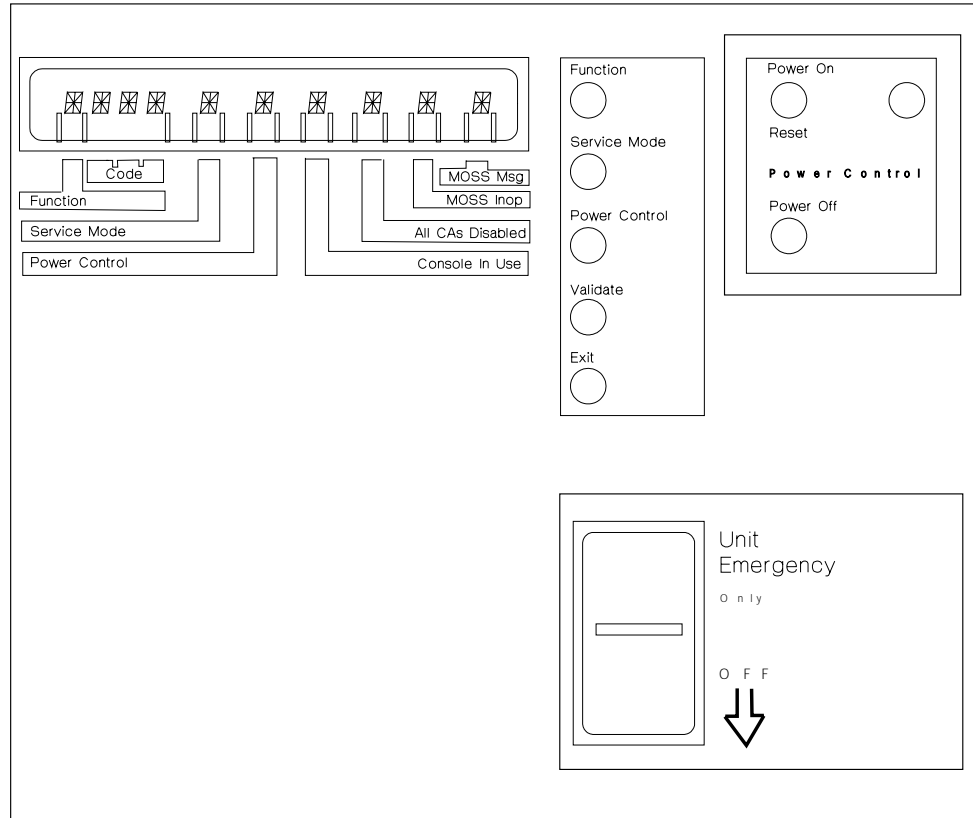

Figure A-1. 3745 Control Panel

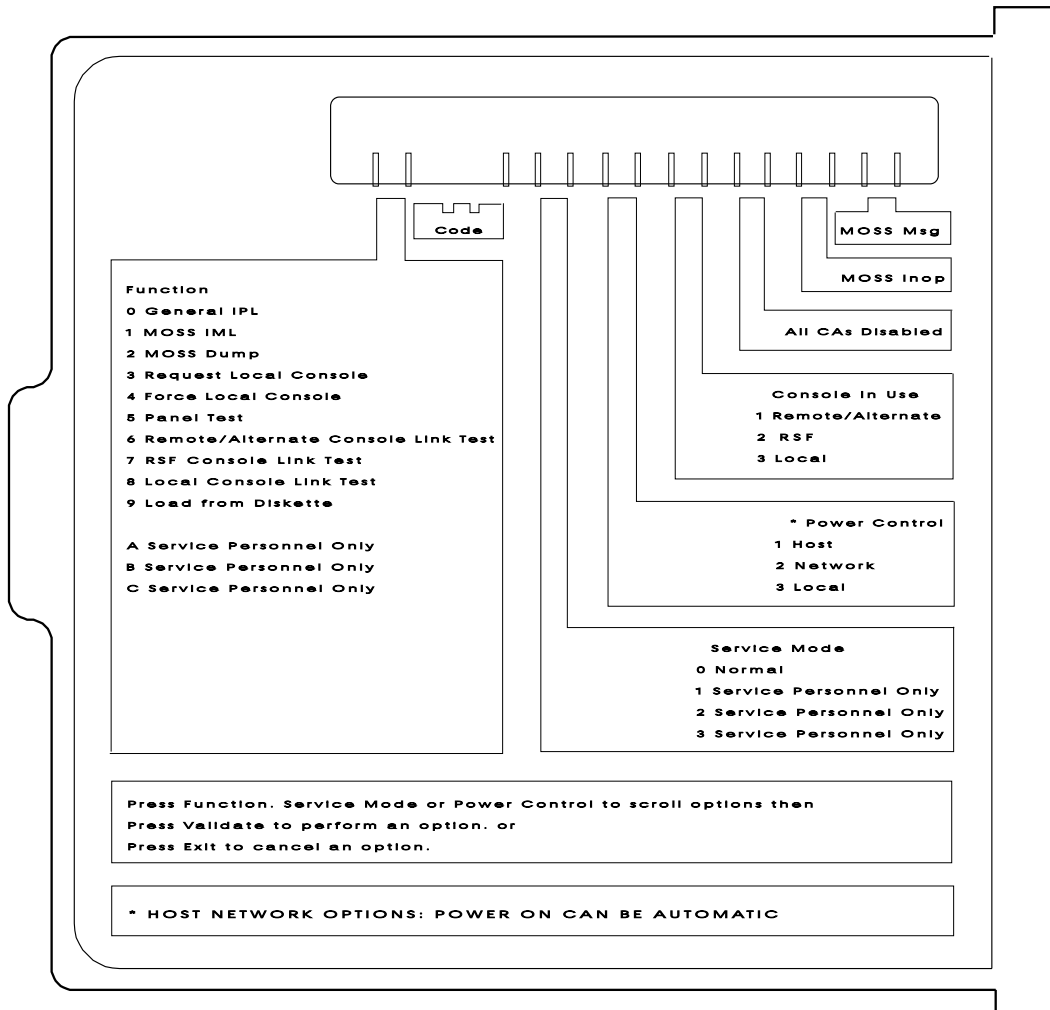

Figure A-2. 3745 Control Panel Reference Card



## Function Display

### Attention

The same control panel numbers on the 3745 and 3746-900 do not always share the same function.

The display at the top shows the number of the function that you have selected.

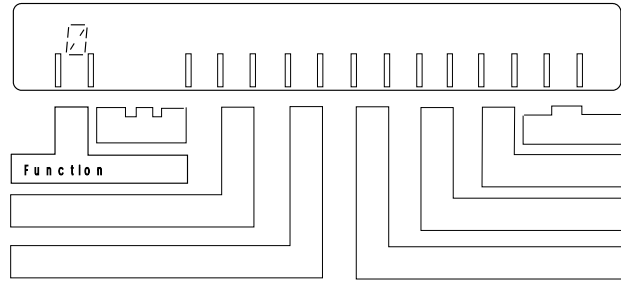

To select the number for a function:

1. Press **Function** repeatedly until the number that you want displays.
2. Press **Validate**.

## Function Numbers

The following is a list of numbers and their corresponding functions:

1	To IPL the 3745.
1	To IML the MOSS.
2	To dump the MOSS to disk.
3	Reserved.
4	Reserved.
5	To test the panel (see the <i>Problem Determination Guide</i> , SA33-0096).
6	Reserved. Code 09E is displayed.
7	Reserved. Code 09E is displayed.
8	Reserved. Code 09E is displayed.
9	To IPL the 3745 from the diskette.
0, 1, 2, 3, 4	For Service representatives only.

---

## Code Display

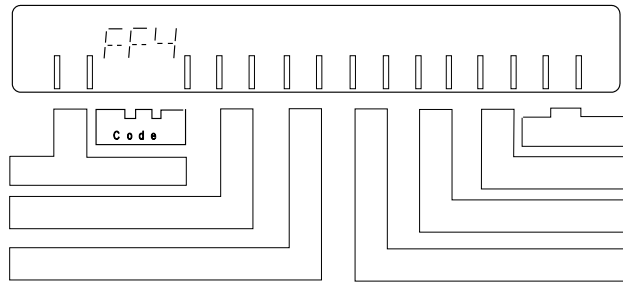

Three character hexadecimal codes display in the main control panel display above the **Code** button. For an explanation of these codes, see page A-9.

---

## Service Mode Display

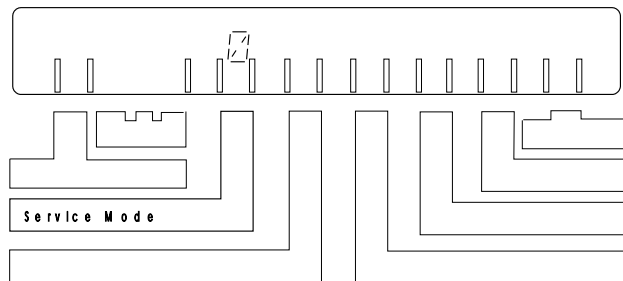

The number in the display above the **Service Mode** button indicates the service mode of the controller.

The numbers and their corresponding functions are as follows:

$\overline{2}$	Customer mode.
$\overline{1}$ , $\overline{2}$ , or $\overline{3}$	Service representative only.

**Note:** If  $\overline{2}$  is not displayed, follow these instructions:

- Press **Service Mode** repeatedly until  $\overline{2}$  displays.
- Press **Validate**.
- IML the MOSS from the control panel as described on page 11-4.

---

## Power Control Display

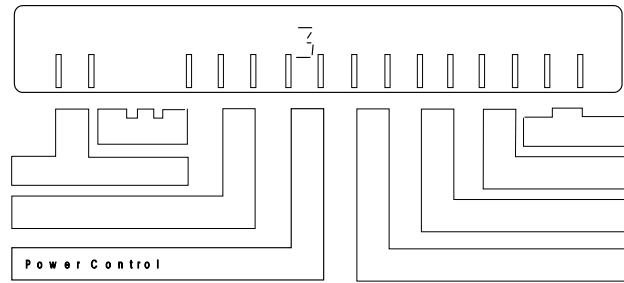

The number in the display above the **Power Control** button indicates the power control mode of the controller. To select a number:

- Press **Power Control** until the number that you want displays.
- Press **Validate**.

The numbers and their corresponding functions are as follows:

**1 (HOST)** The 3745 is activated or deactivated from the host. This means that if ac power is lost and then restored, the host will initiate an automatic restart.

**2 (NETWORK)** The 3745 is activated by one of the following:

- From the control panel (**Power On Reset** pushbutton).
- By a scheduled power ON.

The 3745 is deactivated by a remote power OFF (RPO) command. If power is lost then restored, an automatic restart is performed.

**3 (LOCAL)** The 3745 is activated or deactivated from the control panel. If power is lost then restored, an automatic restart is not initiated.

---

## Console in Use Display

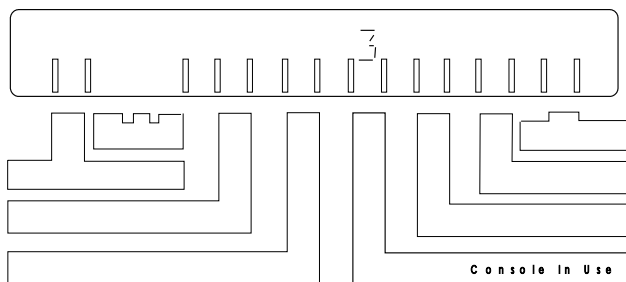

The number in the display above the **Console in Use** button indicates the logged on operator console. The numbers and their corresponding meanings are as follows:

3            The MOSS console is logged on using the service processor or DCAF<sup>1</sup>.

1, 2        No longer available for 3745 Models A.

**Note:** If the display is blank, this indicates that the MOSS console has not been logged on by the service processor or by DCAF.

---

## All 3745 CAs Disabled Indicator

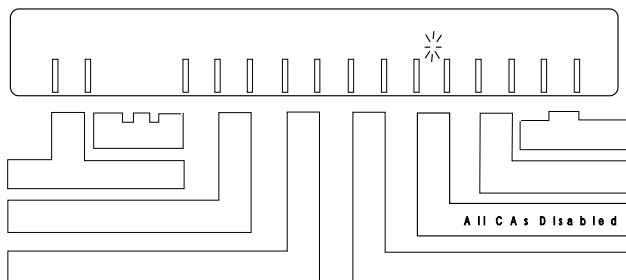

An indicator light in the main control panel display above the **All CAs Disabled** button indicates that all the channel adapters are disabled. If there is no indicator light, this means that at least one channel adapter is enabled.

---

## MOSS Inop Indicator

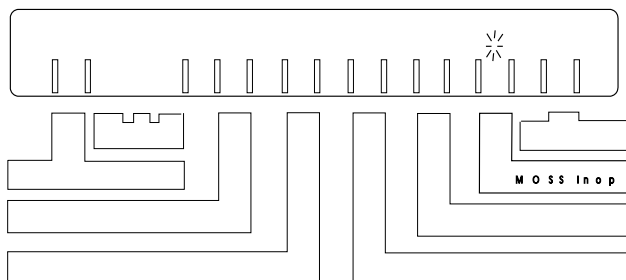

---

<sup>1</sup> The DCAF program is contained in Tivoli Management Environment (TME) 10 Remote Control. For the purposes of this guide, DCAF is referred to instead of TME 10 Remote Control.

An indicator light in the main control panel above the **MOSS Inop** button indicates that the MOSS is not working. If the indicator light appears, see the *Problem Determination Guide*. Also, if  displays, contact the person in charge of 3745 problem analysis (see page 1-5).

---

## MOSS Message Indicator

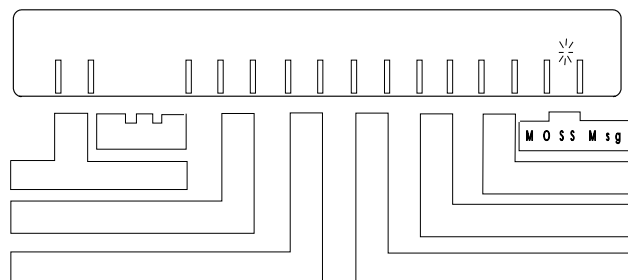

An indicator light in the main control panel above the **MOSS Msg** button generates an alarm. If this indicator light appears, see the online *Problem Analysis Guide*.

---

## Pushbuttons and Power ON Indicator

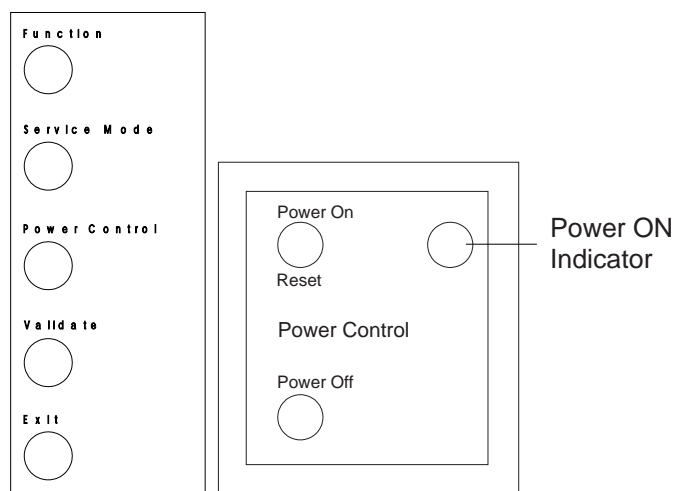

### Function

Selects a control panel function (see page A-3).

### Service Mode

Selects a service mode (see page A-4).

### Power Control

Selects a power control mode (see page A-5).

### Validate

Performs or validates the selected function, service mode, or power control mode.

### Exit

Cancels an invalidated function, service mode, or power control option.

**Power On Reset**

Reactivates the 3745.

**Power Off**

Deactivates the 3745. If you have to power ON again, wait 10 seconds before pressing **Power On Reset**.

**Power ON Indicator**

Indicates that the 3745 is powered ON.

---

## Stop Switch

The stop switch is located on the main 3745 control panel.

**Attention**

Even if the stop switch is in the OFF position, the primary power box is still connected to the electric current.

To disconnect completely, do the following:

1. Turn off the main circuit breaker.
2. Remove the power plugs from supply outlets.

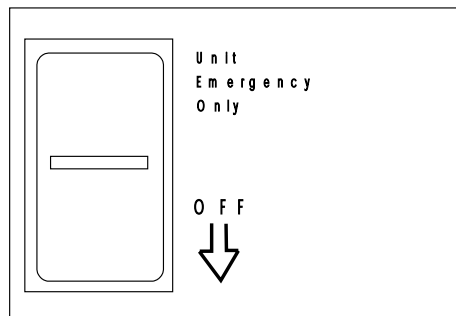

Figure A-3. IBM 3745 Control Panel

Use the OFF switch only in an emergency. The OFF switch immediately forces the 3745 and 3746-900 to power OFF. If you use this switch, only an IBM service representative is authorized to restart the controller.

---

## Hexadecimal Codes

The hexadecimal codes on the control panel indicate the following:

- The progress of a function (for example, IPL).
- The status of 3745 components.
- An error, indicated by a blinking code.

The following list show the codes for normal operating conditions. Other codes, indicating the progress of a function, may display for a short while. However, if a code remains displayed for more than 2 minutes, contact the person in charge of 3745 problem analysis (see page 1-5).

**Note:** The online *Problem Analysis Guide* gives a complete explanation of the hexadecimal codes for Models A.

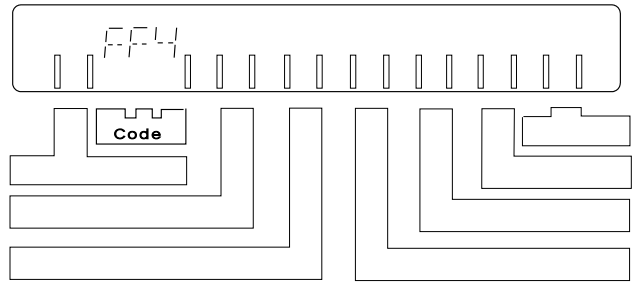

The following hexadecimal codes display during a normal IPL for a 3745.

<b>Code</b>	<b>Explanation and Action</b>
-------------	-------------------------------

<b>000</b>	A successful IPL for the 3745. The control program is loaded and MOSS is online.
<b>09E</b>	You selected a reserved function with the control panel function button. The controller does not respond to this selection.
<b>DFC</b>	Wrong diskette in drive. Insert the correct primary diskette. Restart IPL in diskette mode.
<b>F0E</b>	MOSS IML successfully completed. MOSS is alone.
<b>F0F</b>	MOSS IML successfully completed. CCU is running and MOSS is offline or IPL complete in diskette mode.
<b>F28</b>	Failed diskette. Retry with another diskette. If you do not have other diskettes for saving data, contact the person in charge of 3745 problem analysis (see page 1-5).
<b>FD6</b>	Control program loading from disk in progress. If this code displays for more than 2 minutes, contact the person in charge of 3745 problem analysis (see page 1-5).
<b>FD7</b>	Control program dump to disk in progress. If this code remains more than 4 minutes, contact the person in charge of 3745 problem analysis (see page 1-5).
<b>FD8</b>	Control program save on disk in progress. If this code remains more than 2 minutes, contact the person in charge of 3745 problem analysis (see page 1-5).
<b>FF0</b>	Start of 3745 IPL. If this code remains more than 2 minutes, contact the person in charge of 3745 problem analysis (see page 1-5).
<b>FF1</b>	3745 IPL phase one. If this code remains more than 5 minutes, contact the person in charge of 3745 problem analysis (see page 1-5).
<b>FF2</b>	3745 IPL phase two. If this code remains more than 2 minutes, contact the person in charge of 3745 problem analysis (see page 1-5).
<b>FF3</b>	3745 IPL phase three. If this code remains more than 5 minutes, contact the person in charge of 3745 problem analysis (see page 1-5).

- FF4** 3745 IPL phase four. The control program will be loaded from the host.
- FF5** For a channel-attached 3745, control program(s) being loaded. If this code remains more than 2 minutes, contact the person in charge of 3745 problem analysis (see page 1-5).
- FF6** For a link-attached 3745, control programs being loaded. For a link-attached 3745, the time of the code display depends on the size of the load module and the speed of the link.
- FF7** The control program is loaded.
- FFB** 3745 IPL canceled on operator request.
- FFE** 3745 IPL complete with non-disruptive errors. If this recurs, contact the person in charge of 3745 problem analysis (see page 1-5).



# Appendix B. 3746 Operator Control Panel

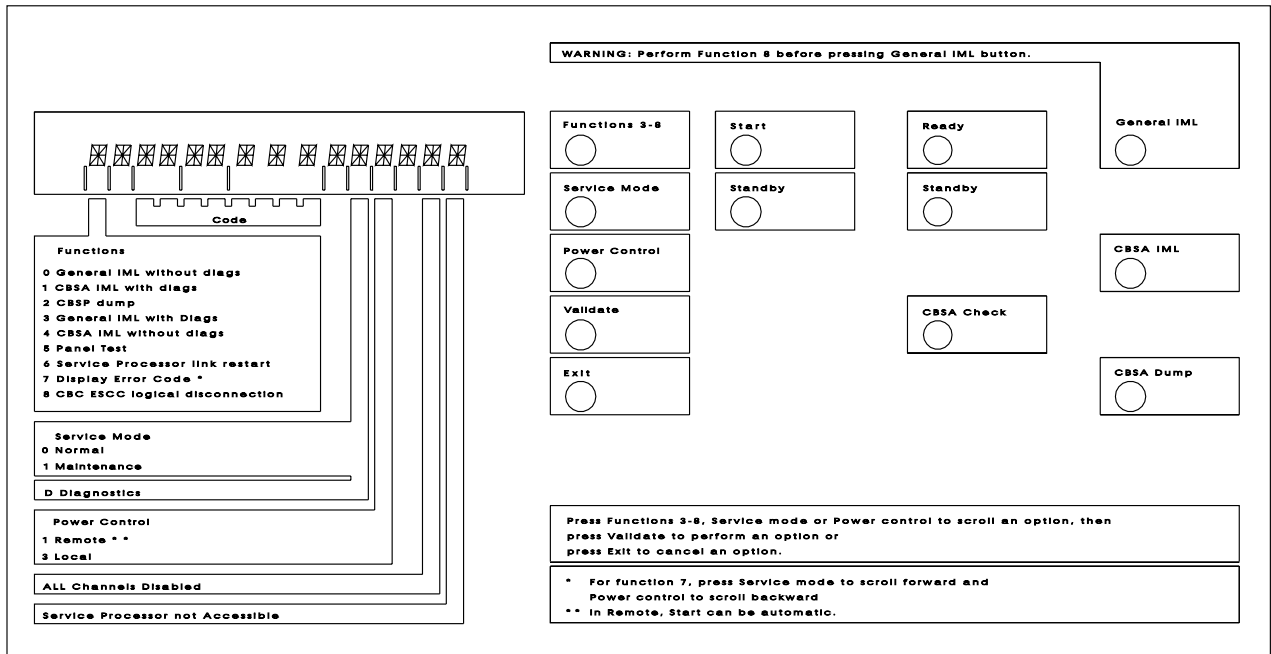
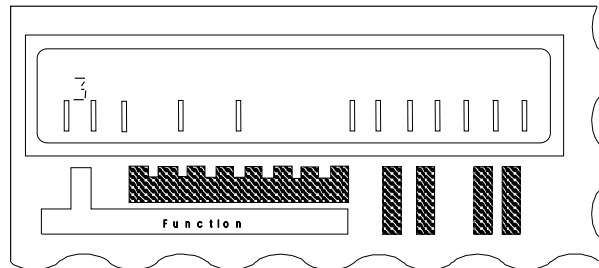

Figure B-1. 3746 Control Panel

## Function Display



**Note**

The same control panel numbers on the 3746 and the 3745 do not always share the same function.

## Specific Button Selections

Functions 0, 1, and 2 are enabled by the **Function** button on the display panel, and also display automatically when you press the corresponding control panel buttons (**General IML**, **CBSA IML**, and **CBSP Dump**). Functions 3 to 8 are also enabled by the **Function** button on the display panel.

### 0 - General IML

Resets and performs an IML for all 3746 processors.

#### Attention

You must perform function "8 - CBC/ESCC logical disconnection" on page B-3 before running function 0.

Use this function after one of the following:

- Power ON.
- In an emergency, when the MOSS-E function **Perform a general IML** does not run. For more information, see "Activation and IML from the 3746 Operator Control Panel" on page 11-10.

### 1 - CBSA IML with Diags

Runs a diagnostics and IML for the CBSA (Controller Bus and Service Adapter).

**Note:** Mainly used by an IBM service representative.

### 2 - CBSP Dump

Transfers a CBSP dump to the MOSS-E on the service processor disk.

**Note:** Mainly used by the an IBM service representative.

## Selections Using the Function Button

To select functions 3-8, perform the following:

1. Press **Function** repeatedly until the number of the function that you want displays on the control panel.
2. Press **Validate** to start the function.

### 3 - General IML with Diags

Performs an IML and diagnostics for all 3746 processors.

**Note:** Mainly used by an IBM service representative.

### 4 - CBSA IML

Performs an IML for the CBSA (Controller Bus and Service Adapter).

**Note:** Mainly used by an IBM service representative.

### 5 - Panel Test

Runs a diagnostics of the control panel. Before you can use this function, make sure that **Service Mode 1** is selected (see "Service Mode" on page B-3).

**Note:** Mainly used by an IBM service representative.

## 6 - Console Link Restart

Re-establishes the link between the 3746 and the service processor.

**Note:** Only used by an IBM service representative.

## 7 - Display Error Code

Displays error codes.

**Note:** Only used by an IBM service representative.

## 8 - CBC/ESCC logical disconnection

Press this before using function 0, **General IML without diags.**

---

## Hexadecimal Codes

Hexadecimal codes display on the control panel during the following processes:

### IML and IPL progression codes

Track the different phases of a process and indicate when a process is complete.

### Error codes

Blink on the display and indicate a problem with normal operations.

### Standby codes

Indicate the status of the machine when it is not totally activated.

More information on hexadecimal codes is contained online, in the *Problem Analysis Guide*.

---

## Service Mode

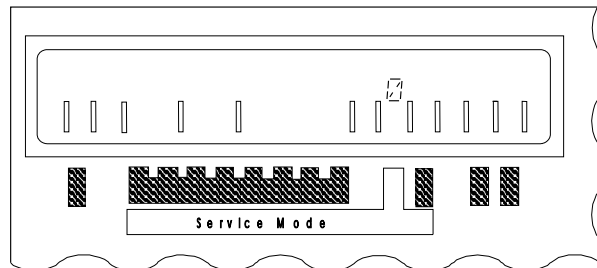

### 0 - Normal

The mode for normal operations.

### 1 - Maintenance

Used only by an IBM service representative.

### D - Diagnostics

You cannot select this from the control panel. Displays only when certain diagnostics are run by the service representative.

---

## Power Control

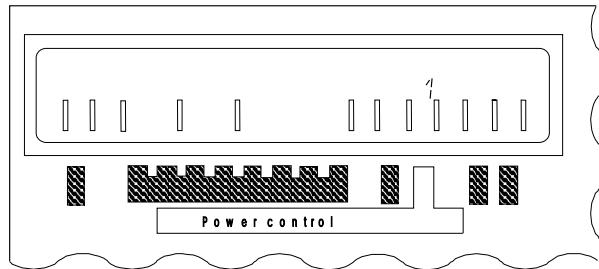

### 1 - Remote

Mode for normal operations. In normal mode, you can perform the following:

- Activate and deactivate the 3746 from:
  - Attached host
  - 3745
  - Service processor.
- Automatic power ON restart, and IML if ac power is lost and restored.
- For a remote 3746, deactivation from a VTAM remote power OFF command (RPO).

### 3 - Local

Used only by an IBM service representative.

---

## All ESCON Channel Adapters Disabled

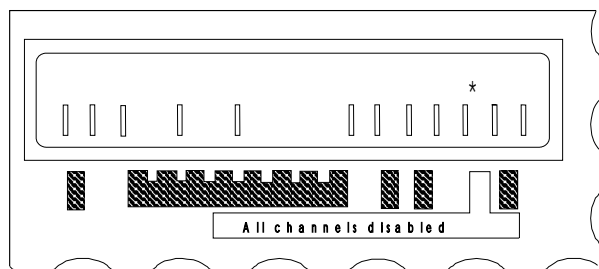

The display is blank if at least one channel adapter (CA) is enabled.

\* All CAs are disabled.

---

## Service Processor Inaccessible

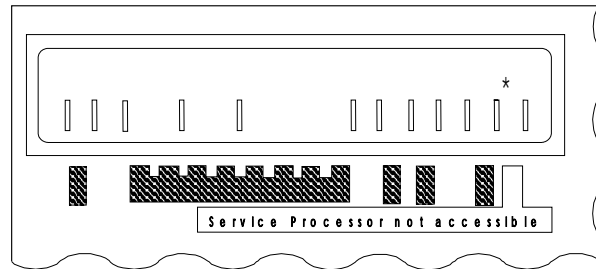

The display is blank if the MOSS-E console is accessible.

- \* MOSS-E console is inaccessible. This means that the link between the MOSS-E in the service processor and the 3746 has failed or was not established. The MOSS-E can run, but it cannot exchange data with the 3746.

Other codes briefly display during power ON, IML or when there is a problem. If you want more details on these characters, see the *Problem Analysis Guide*.



## Appendix C. Bibliographies

### Customer Documentation for the 3745 (Models 210, 310, 410, 610, 21A, 31A, 41A, and 61A), and 3746 (Model 900)







Table C-1 (Page 1 of 4). Customer Documentation for the 3745 Models X10 and X1A, and 3746 Model 900		
This customer documentation has the following formats:		
		
Finding Information		
<b>3745 Models A and 3746 Books</b>		
Starting with engineering change (EC) F12380, all of the books in the 3745 Models A and 3746 library are available on the CD-ROM that contains the Licensed Internal Code (LIC) for this EC.		
	SA33-0172	<p><b>IBM 3745 Communication Controller Models 210 to 61A</b>  <b>IBM 3746 Expansion Unit Model 900</b>  <b>Customer Master Index<sup>1</sup></b></p> <p>Provides references for finding information in the customer documentation library.</p>
Evaluating and Configuring		
	GA33-0092	<p><b>IBM 3745 Communication Controller Models 210, 310, 410, and 610</b>  <b>Introduction</b></p> <p>Gives an introduction of the IBM Models 210 to 610 capabilities. For Models A refer to the <i>Overview</i>, GA33-0180.</p>
	GA33-0180	<p><b>IBM 3745 Communication Controller Models A<sup>2</sup></b>  <b>IBM 3746 Nways Multiprotocol Controller Models 900 and 950</b>  <b>Overview</b></p> <p>Gives an overview of connectivity capabilities within SNA, APPN, and IP networking.</p>

Table C-1 (Page 2 of 4). Customer Documentation for the 3745 Models X10 and X1A, and 3746 Model 900

	GA33-0457	<p><b>IBM 3745 Communication Controller Models A<sup>2</sup></b>  <b>IBM 3746 Expansion Unit Model 900</b>  <b>Models 900 and 950</b></p> <p><b>Planning Guide</b></p> <p>Planning for:</p> <ul style="list-style-type: none"> <li>• Field upgrades</li> <li>• Service processor and alert management configuration</li> <li>• Network integration (NCP, APPN, and IP control)</li> <li>• Physical installation.</li> </ul>
<b>Preparing Your Site</b>		
	GC22-7064	<p><b>IBM System/360, System/370, 4300 Processor</b></p> <p><b>Input/Output Equipment Installation Manual-Physical Planning</b>  (Including Technical News Letter GN22-5490)</p> <p>Provides information for physical installation for the 3745 Models 130 to 610. For 3745 Models A and 3746 Model 900, refer to the <i>Planning Guide</i>, GA33-0457.</p>
	GA33-0127	<p><b>IBM 3745 Communication Controller</b>  <b>Models 210, 310, 410, and 610</b></p> <p><b>Preparing for Connection</b></p> <p>Helps for preparing the 3745 Models 210 to 610 cable installation. For 3745 Models A refer to the <i>Connection and Integration Guide</i>, SA33-0129.</p>
<b>Preparing for Operation</b>		
	GA33-0400	<p><b>IBM 3745 Communication Controller All Models<sup>3</sup></b>  <b>IBM 3746 Nways Multiprotocol Controller</b>  <b>Models 900 and 950</b></p> <p><b>Safety Information<sup>1</sup></b></p> <p>Provides general safety guidelines.</p>
	SA33-0129	<p><b>IBM 3745 Communication Controller All Models<sup>3</sup></b>  <b>IBM 3746 Nways Multiprotocol Controller Model 900</b></p> <p><b>Connection and Integration Guide<sup>1</sup></b></p> <p>Contains information for connecting hardware and integrating network of the 3745 and 3746-900 after installation.</p>
	SA33-0416	<p><b>Line Interface Coupler Type 5 and Type 6</b>  <b>Portable Keypad Display</b></p> <p><b>Migration and Integration Guide</b></p> <p>Contains information for moving and testing LIC types 5 and 6.</p>



Table C-1 (Page 3 of 4). Customer Documentation for the 3745 Models X10 and X1A, and 3746 Model 900











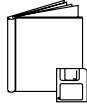

	SA33-0158	<p><b>IBM 3745 Communication Controller All Models<sup>3</sup></b>  <b>IBM 3746 Nways Multiprotocol Controller Model 900</b></p> <p><b>Console Setup Guide<sup>1</sup></b></p>
<p>Provides information for:</p> <ul style="list-style-type: none"> <li>• Installing local, alternate, or remote consoles for 3745 Models 130 to 610</li> <li>• Configuring user workstations to remotely control the service processor for 3745 Models A and 3746 Model 900 using: <ul style="list-style-type: none"> <li>– DCAF program</li> <li>– Telnet Client program.</li> </ul> </li> </ul>		
<b>Customizing Your Control Program</b>		
	SA33-0178	<p><b>Guide to Timed IPL and Rename Load Module</b></p>
<p>Provides VTAM procedures for:</p> <ul style="list-style-type: none"> <li>• Scheduling an automatic reload of the 3745</li> <li>• Getting 3745 load module changes transparent to the operations staff.</li> </ul>		
<b>Operating and Testing</b>		
	SA33-0098	<p><b>IBM 3745 Communication Controller All Models<sup>4</sup></b></p> <p><b>Basic Operations Guide<sup>1</sup></b></p>
<p>Provides instructions for daily routine operations on the 3745 Models 130 to 610.</p>		
	SA33-0177	<p><b>IBM 3745 Communication Controller Models A<sup>2</sup></b>  <b>IBM 3746 Nways Multiprotocol Controller Model 900</b></p> <p><b>Basic Operations Guide<sup>1</sup></b></p>
<p>Provides instructions for daily routine operations on the 3745 Models 17A to 61A, and 3746 Model 900 operating as an SNA node (using NCP), APPN/HPR Network Node, and IP Router.</p>		
	SA33-0097	<p><b>IBM 3745 Communication Controller All Models<sup>3</sup></b></p> <p><b>Advanced Operations Guide<sup>1</sup></b></p>
<p>Provides instructions for advanced operations and testing, using the 3745 MOSS console.</p>		
	On-line Information	<p><b>Controller Configuration and Management Application</b></p>
<p>Provides a graphical user interface for configuring and managing a 3746 APPN/HPR Network Node and IP Router, and its resources. Is also available as a stand-alone application, using an OS/2 workstation. Defines and explains all the 3746 Network Node and IP Router configuration parameters through its online help.</p>		

Table C-1 (Page 4 of 4). Customer Documentation for the 3745 Models X10 and X1A, and 3746 Model 900

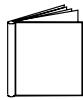
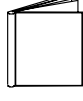
	SH11-3081	<p><b>IBM 3746 Nways Multiprotocol Controller Models 900 and 950</b></p> <p><b>Controller Configuration and Management: User's Guide<sup>5</sup></b></p>
Explains how to use CCM and gives examples of the configuration process.		
<b>Managing Problems</b>		
	SA33-0096	<p><b>IBM 3745 Communication Controller All Models<sup>3</sup></b></p> <p><b>Problem Determination Guide<sup>1</sup></b></p>
A guide to perform problem determination on the 3745 Models 130 to 61A.		
	On-line Information	<b>Problem Analysis Guide</b>
An online guide to analyze alarms, events, and control panel codes on:		
<ul style="list-style-type: none"> <li>• IBM 3745 Communication Controller Models A<sup>2</sup></li> <li>• IBM 3746 Nways Multiprotocol Controller Models 900 and 950.</li> </ul>		
	SA33-0175	<p><b>IBM 3745 Communication Controller Models A<sup>2</sup></b></p> <p><b>IBM 3746 Expansion Unit Model 900</b></p> <p><b>IBM 3746 Nways Multiprotocol Controller Model 950</b></p> <p><b>Alert Reference Guide</b></p>
Provides information about events or errors reported by alerts for:		
<ul style="list-style-type: none"> <li>• IBM 3745 Communication Controller Models A<sup>2</sup></li> <li>• IBM 3746 Nways Multiprotocol Controller Models 900 and 950.</li> </ul>		
<p><sup>1</sup> Documentation shipped with the 3745.</p> <p><sup>2</sup> 3745 Models 17A to 61A.</p> <p><sup>3</sup> 3745 Models 130 to 61A.</p> <p><sup>4</sup> Except 3745 Models A.</p> <p><sup>5</sup> Documentation shipped with the 3746-900.</p>		

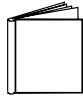
## Additional Customer Documentation for the 3745 Models 130, 150, 160, 170, and 17A

<i>Table C-2. Additional Customer Documentation for the 3745 Models 130 to 17A</i>		
This customer documentation has the following format:		
		
<b>Finding Information</b>		
	SA33-0142	<p><b><i>IBM 3745 Communication Controller Models 130, 150, 160, 170, and 17A IBM 3746 Nways Multiprotocol Controller Model 900 Customer Master Index<sup>1</sup></i></b></p> <p>Provides references for finding information in the customer documentation library.</p>
<b>Evaluating and Configuring</b>		
	GA33-0138	<p><b><i>IBM 3745 Communication Controller Models 130, 150, and 170 Introduction</i></b></p> <p>Gives an introduction about the IBM Models 130 to 170 capabilities, including Model 160.</p> <p>For Model 17A refer to the <i>Overview</i>, GA33-0180.</p>
<b>Preparing Your Site</b>		
	GA33-0140	<p><b><i>IBM 3745 Communication Controller Models 130, 150, 160, and 170 Preparing for Connection</i></b></p> <p>Helps for preparing the 3745 Models 130 to 170 cable installation.</p> <p>For 3745 Model 17A refer to the <i>Connection and Integration Guide</i>, SA33-0129.</p>
<p><sup>1</sup> Documentation shipped with the 3745.</p>		



---

## List of Abbreviations

<b>ac</b>	alternating current	<b>LA</b>	Line Adapter
<b>APPN</b>	Advanced Peer-to-Peer Networking	<b>LAN</b>	Local Area Network
<b>ARC</b>	Active Remote Connector	<b>LAPS</b>	LAN Adapter Protocol Support
<b>ARP</b>	Address Resolution Protocol	<b>LCB</b>	Line Connection Box
<b>ASCII</b>	American Standard Code for Information Interchange	<b>LCBB</b>	Line Connection Box Base
<b>ATM</b>	Asynchronous Transfer Mode	<b>LCBE</b>	Line Connection Box Expansion
<b>BGP</b>	Border Gateway Protocol	<b>LIC</b>	Line Interface Coupler
<b>CA</b>	Channel Adapter		Licensed Internal Code
<b>CB</b>	Circuit Breaker	<b>LIC11</b>	Line Internal Coupler type 11
<b>CBC</b>	Controller Bus Coupler	<b>LU</b>	Logical Unit
<b>CBSA</b>	Controller Bus and Service Adapter	<b>MAE</b>	Multiaccess Enclosure
<b>CBSP</b>	Controller Bus and Service Processor	<b>MOSS</b>	Maintenance and Operator Subsystem
<b>CCU</b>	Central Control Unit	<b>MOSS-E</b>	Maintenance and Operator Subsystem - Extended
<b>CCM</b>	Controller Configuration and Management	<b>MSA</b>	Machine Status Area
<b>CDF-E</b>	Configuration Data File-Extended	<b>NCP</b>	Network Control Program
<b>CLA</b>	Communication Line Adapter	<b>NDF</b>	Network Definition File
<b>CLDP</b>	Controller Load/Dump Program	<b>NN</b>	Network Node
<b>CLP</b>	Communication Line Processor	<b>NNP</b>	Network Node Processor
<b>CP</b>	Control Program (SNA environment) Control Point (APPN environment)	<b>NPM</b>	NetView Performance Monitor
<b>CPU</b>	Central Processing Unit	<b>OPCON</b>	Operator Console
<b>CSR</b>	CCU Selection and Release	<b>OS</b>	Operating System
<b>DLUR</b>	Dependent LU Requester	<b>OSPF</b>	Open Shortest Path First
<b>EGA</b>	ESCON Generation Assistant	<b>PCMCIA</b>	Personal Computer Memory Card International Association
<b>ELS</b>	Event Logging System	<b>PE</b>	Product Engineer
<b>EPO</b>	External Power ON	<b>PPP</b>	Point-to-Point Protocol
<b>ESCC</b>	ESCON Coupler	<b>PU</b>	Physical Unit
<b>ESCON</b>	Enterprise System Connection	<b>RETAIN</b>	Remote Technical Assistance Information Network
<b>ESCP</b>	ESCON Processor	<b>RIP</b>	Routing Information Protocol
<b>FP</b>	Focal Point	<b>ROPCON</b>	Remote Operator Console
<b>GWCON</b>	Gateway Console	<b>RPO</b>	Remote Power OFF
<b>HPR</b>	High Performance Routing	<b>RSF</b>	Remote Support Facility
<b>IML</b>	Initial Microcode Load	<b>SDLC</b>	Synchronous Data Link Control
<b>IP</b>	Internet Protocol	<b>SNA</b>	Systems Network Architecture
<b>IPL</b>	Initial Program Load	<b>SNMP</b>	Simple Network Management Protocol
<b>ISDN</b>	Integrated Services Digital Network	<b>SPAU</b>	Service Processor Access Unit
<b>kbps</b>	kilobits per second	<b>TCP/IP</b>	Transmission Control Protocol/Internet Protocol

**TFTP** Trivial File Transfer Protocol  
**TIC** Token-ring Interface Coupler  
**TRA** Token-ring Adapter

**TRP** Token-ring Processor  
**URL** Uniform Resource Locator  
**VTAM** Virtual Telecommunications Access Method

---

## Glossary

This glossary defines all new terms used in this manual. It also includes terms and definitions from the *IBM Dictionary of Computing*, SC20-1699.

**Address Resolution Protocol (ARP).** One of the protocols of TCP/IP for dynamically mapping routes between Internet addresses, baseband adapter addresses, X.25 addresses, and token-ring adapter addresses on a local area network (LAN).

**Advanced Peer-to-Peer Networking (APPN).** Data communication support that routes data in a network between two or more advanced program-to-program communications (APPC) systems that do not need to be adjacent.

**alarm.** A message sent to the MOSS operator console. In case of an error, a reference code identifies the nature of the error.

**alert.** A message sent to the host console. In case of an error, a reference code identifies the nature of the error.

**central control unit (CCU).** In the 3745, the controller hardware unit that contains the circuits and data flow paths needed to execute instructions and to control its storage and the attached adapters.

**channel adapter (CA).** A communication controller hardware unit used to attach the controller to a host processor.

**channel interface.** The interface between the controller and the host processors.

**circuit breaker (CB).** A switch that automatically interrupts an electric circuit because of an abnormal condition.

**communication controller.** A communication control unit that is controlled by a program stored and executed in the unit. Examples are the IBM 3705, IBM 3725/3726, IBM 3720, and IBM 3745 models 130, 150, 170, 21A, 31A, 41A, and 61A. More recent in this family are the IBM 3746 models 900 and 950.

**configuration data file (CDF).** A MOSS file that contains a description of all the hardware features (presence, type, address, and characteristics) of the 3745 controller.

**configuration data file-extended (CDF-E).** A MOSS-E file that contains a description of all the hardware features (presence, type, address, and characteristics) of the 3746 Model 900 controller.

**control panel.** A panel that contains switches and indicators for the customer's operator and service personnel.

**control point (CP).** A collection of tasks, which provide directory and route selection functions for APPN. An end node control point provides its own configuration, session, and management services with assistance from the control point in its serving network node. A network node control point provides session and routing service.

**control program.** A computer program designed to schedule and to supervise the execution of programs of the controller.

**diskette.** For IBM 3745 operator control panel, a thin, flexible magnetic disk, and its protective jacket, that records diagnostics, microcode, and files. Diskette size is 5"25. For service processor the diskette size is 3"5.

**diskette drive.** A mechanism that reads and writes diskettes.

**Distributed Console Access Facility (DCAF).** An IBM licensed program that enables a user at one workstation to remotely control, monitor, and operate another workstation.

**emulation program.** A program that enables a system or a device to operate as if it were a different system or device.

**Enterprise System Connection (ESCON).** A set of IBM products and services that combines fiber optic technology with I/O architecture. ESCON provides a highly flexible channel interconnection environment with an extended distance range.

**fallback.** In twin backup mode, the traffic of a failing CCU is redirected to the second CCU.

In standby mode, the traffic of a failing CCU is redirected to the standby CCU after it is IPLed.

**focal point (FP).** An APPN network node that receives alerts. A focal point allows a customer to centrally manage a network.

**host processor.** (1) A processor that controls all or part of a user application network. (2) In a network, the processing unit in which the access method for the network resides. (3) In an SNA network, the processing unit that contains a system services control point (SSCP). (4) A processing unit that executes the access method for attached communication controllers. Also called *host*.

## Glossary

**IBM service representative.** An individual in IBM who performs maintenance services for IBM products or systems.

**initial microcode load (IML).** The process of loading the microcode into a scanner or into MOSS.

**initial program load (IPL).** The initialization procedure that causes the 3745 control program to start operation.

**integrated services digital network (ISDN).** A digital end-to-end telecommunication network that supports multiple services including, but not limited to, voice and data.

**Internet Protocol (IP).** In TCP/IP, a protocol that routes data from its source to its destination in an Internet environment.

**LIC unit.** For IBM 3745, a line interface coupler unit (LIU) consisting of:

- One power supply (PS) associated with
- Two line interface boards (LIBs), housing
- Multiplex cards (DMUX, SMUXA, or SMUXB), and
- Line interface coupler cards (LICs).

**line.** See *transmission line*.

**line adapter (LA).** The part of the TSS, HPTSS, ESS, or TRSS that scans and controls the transmission lines. Also called *scanner* or *communication scanner*.

- For TSS, the line adapters are low-speed scanners (LSSs).
- For HPTSS, the line adapters are high-speed scanners (HSSs).
- For ESS, the line adapters are Ethernet LAN adapters (ELA).
- For TRSS, the line adapters are token-ring adapters (TRAs).

**line interface coupler (LIC).** A circuit that attaches up to four transmission cables to the controller (from DTEs, DCEs, or telecommunication lines).

**local area network (LAN).** A computer network located on a user's premises within a limited geographical area. Communication within a LAN is not subject to external regulation; however, communication across the LAN boundary may be subject to some form of regulation.

**logical unit (LU).** In SNA, a port through which an end user accesses the SNA network in order to communicate with another end user and through which the end user accesses the functions provided by system services control points (SSCPs). An LU can support at least two sessions, one with an SSCP and one with another LU, and may be capable of supporting many sessions with other logical units.

**Maintenance and Operator Sub-System (MOSS).**

The part of the controller that provides operating and servicing facilities to the user's operator and the IBM service representative.

**Maintenance and Operator Sub-System-Extended (MOSS-E).** The licensed internal code loaded on the service processor fixed disk to provide maintenance and operator facilities to the user and IBM service representative.

**microcode.** A program that is loaded in a processor (for example, the MOSS processor) to replace a hardware function. The microcode is not accessible to the customer.

**Multiaccess Enclosure (MAE).** A super processor for the 3746-9x0 with a direct hardware attachment to the controller connectivity switch. The MAE houses eight adapter slots with up to eight ports per adapter, and handles multiple traffic routing for TCP/IP, SNA/DLUR, APPN, and HPR protocols.

**NetView Performance Monitor (NPM).** An IBM licensed program that collects, monitors, analyses, and displays data relevant to the performance of a VTAM telecommunication network. It runs as an on-line VTAM application program.

**network.** See *user application network*.

**Network Control Program (NCP).** An IBM licensed program that provides communication controllers supports for single-domain, multiple domain, and interconnected network capability.

**offline.** Status of MOSS when the later is not connected to the CCU control program.

**remote service facility (RSF).** RSF provides IBM maintenance assistance when requested via the public switched network. It is connected to the IBM RETAIN database system.

**single.** Configuration with one CCU.

**switchback.** Operation to reset a twin backup configuration from fallback to initial state.

**Synchronous Data Link Control (SDLC).** A discipline conforming to subsets of the Advanced Data Communication Control Procedures (ADCCP) of the American National Standards Institute (ANSI) and High-level Data Link Control (HDLC) of the International Organization for Standardization (IOS), for managing synchronous, code-transparent, serial-by-bit information transfer over a link connection. Transmission exchanges may be duplex or half-duplex over switched or nonswitched links. The configuration of the link connection may be point-to-point, multipoint, or loop.



**time out.** The interval allotted for certain operations to occur.

**token-ring adapter (TRA).** Line adapter for IBM Token-Ring Network, composed of one token-ring multiplexor card (TRM), and two token-ring interface couplers (TICs).

**twin.** 3745 controller configuration with two CCUs.

**twin-dual.** Mode of operation with two CCUs operating simultaneously in two distinct subareas.

**twin-backup.** Mode of operation identical to twin-dual with fallback capability.

**twin-standby.** Mode of operation with one CCU active and the other in standby, ready to take over.

## Glossary

# Index

## Numerics

### 3745 models A

- control panel A-1
- control panel codes A-9
- control panel pushbuttons A-7
- IML from the service processor 11-1
- IPL 7-1, 7-6, 8-1
- power ON 7-1, 7-6
- stop switch A-8

### 3746

- activation from a host 11-9
- activation from the operator panel 11-10
- activation from the service processor 11-7
- control panel B-1
- single IP control point 6-7

## A

### activation (3746)

- from a host 11-9
- from MOSS/E console 11-7
- from the operator panel 11-10
- from the service processor 11-7

### alarm 1-5

### APPN

- control point 4-4
- tasks 4-1

### auto-restart 11-14

## B

### backup

- controller configuration 2-4
- MOSS-E microcode 2-6
- service processor 2-4

## C

### CCM 6-1

- IP resource management 6-1
- MAE configurations 5-2

### CDF-E updating 3-16

### changing MOSS-E passwords 3-3

### channel adapter

- disabling 10-1
- enabling 10-1

### color machine status legend 3-8

### communication controller evolution 1-1

### configuration

- backing up (controller configuration) 2-4

### console

- DCAF Remote Console 2-3

### control panel

- 3745 1-4, A-1
- 3746 1-4, B-1
- function display A-3

### control point functions

- Network Node Processor (NNP) 4-1

### controller

- family evolution 1-1
- installation 3-7
- status 3-6

### controller configurations

- backing up 3-18

## D

### DCAF

- hot keys 3-9

### deactivation (3746)

- from a host 11-9
- from the service processor 11-7

## E

### ESCON

- disabling 10-2
- enabling 10-2

### evolution, communication controller 1-1

## F

### F keys 3-12

### failure, service processor

- recovering from 2-7

### fallback 9-1

### functions

- MOSS-E 3-8
- pending 3-11

## G

### getting started 1-3

## H

### hot keys 3-9

## I

### IBM

- communication controller family 1-1

### IML

- from the 3745 control panel 11-4
- from the 3746 control panel 11-10

## Index

### **IML** *(continued)*

- line adapter (3745) 11-2
- MOSS 11-4
- scanner (3745) 11-2

### **information**

- pull-down menu 3-7

### **installing**

- a controller 3-7

### **IP**

- configuration 6-5
- environment 6-4
- management 6-6
- MOSS-E commands 6-4
- resource management 6-1

### **IP resource management**

- for MAE 6-1
- from CCM 6-1
- from MOSS-E 6-1

### **IPL**

- from service processor 8-1
- messages 8-6

### **IPL of the service processor 3-9**

## **K**

### **keyboard terminology 3-11**

## **L**

### **logoff**

- (MOSS-E) 3-6
- (MOSS) 3-12

### **logon**

- MOSS-E 3-4

## **M**

### **machine**

- menu 3-8
- status area 3-11
- type 3-11

### **MAE**

- additional information 5-6
- ASCII console 5-5
- basic functions 5-1
- Configuration Program 5-3
- direct attachment 5-1
- functions 5-1, 5-4
- Install/Remove/Change LIC 5-4
- introduction 5-1
- perform maintenance 5-5
- prerequisites 5-1
- selective IML 5-6
- single IP control point 6-7

### **MAE transaction speeds**

- hardware connection to controller switch 5-1

### **menu**

- 3745 models A 3-14
- close 3-6
- help 3-8
- information 3-7
- machine 3-8
- MOSS-E 3-8
- open 3-6
- program 3-6
- window 3-7

### **message area 3-11**

### **microcode**

- backing up 2-6

### **MONITR**

- commands 6-7

### **MOSS**

- screen layout 3-10
- selecting functions 3-13
- window 3-10

### **MOSS-E**

- backing up the microcode 2-6
- basic window 3-1
- daily operations 3-1
- IP resource management 6-1
- Log Off 3-6
- Log On 3-4
- menus, tasks, functions 3-8
- password 3-2
- problem 3-9

### **MSA information 3-11**

## **N**

### **network node processor**

- dual function 4-10
- locating 1-3
- states 4-10

### **networking**

- evolution 1-1

### **NNP**

- management function 4-1

## **O**

### **on-line help**

- pull-down menu 3-8

### **OPCON**

- commands 6-5

### **operator console**

- common commands 3-12
- function keys 3-12
- MOSS screen layout 3-10

**P****password**

- MOSS-E 3-2
- restoration 3-7

**power**

- control mode 11-6
- failure 11-14
- local mode 11-6
- remote mode 11-6
- state (3746) 11-6
- switching mode 11-7

**power state (3746)**

- active 11-6
- inactive 11-6

**problem**

- analysis 3-7, 3-8
- with the MOSS-E 3-9
- with the service processor 3-9

**processor**

- network node processor 4-10
- service processor 2-1

**program**

- pull-down menu 3-6

**R**

**recovering from service processor failure 2-7**

**refresh 3-16**

**regaining control of the service processor 3-9**

**restoring a password 3-7**

**S**

**serial number 3-11**

**service processor**

- backup 2-4
- connecting 2-1
- DCAF Remote Console 2-3
- failure recovery 2-7
- IPL 3-9
- locating 1-3
- regaining control 3-9
- sharing 2-2
- using 2-1

**setting**

- the backup service processor 2-4

**shutdown 3-7**

**single IP control point 6-7**

**starting**

- a controller 3-7
- daily operations 3-1

**stop switch for the 3745 1-4**

**switchback 9-3**

**switching**

- between functions 3-15

**system**

- shutdown 3-7

**T****task 3-8**

- MOSS-E 3-8

**Telnet**

- IP resource management 6-1

**U****update**

- CDF-E 3-16

**user profiles**

- Telnet 6-1

**W****window**

- MOSS-E 3-1
- pull-down menu 3-7



---

## Readers' Comments — We'd Like to Hear from You

**3745 Communication Controller Models A**  
**3746 Nways Multiprotocol Controller Model 900**  
**Basic Operations Guide**

**Publication No. SA33-0177-06**

Please send us your comments concerning this book. We will greatly appreciate them and will consider them for later releases of the present book.

If you prefer sending comments by FAX or electronically, use:

- FAX: 33 4 93 24 77 97
- IBM Internal Use: LGERCF at IBMFR
- Internet: lgercf@fr.ibm.com

In advance, thank you.

Your comments:

\_\_\_\_\_  
Name

\_\_\_\_\_  
Address

\_\_\_\_\_  
Company or Organization

\_\_\_\_\_  
Phone No.



Fold and Tape

**Please do not staple**

Fold and Tape

PLACE  
POSTAGE  
STAMP  
HERE

IBM France  
Centre d'Etudes et Recherches  
Service 0798 - BP 79  
06610 La Gaude  
France

Fold and Tape

**Please do not staple**

Fold and Tape







Part Number: 57G7461

Printed in xxxxx

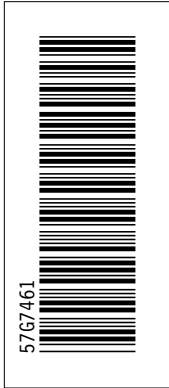
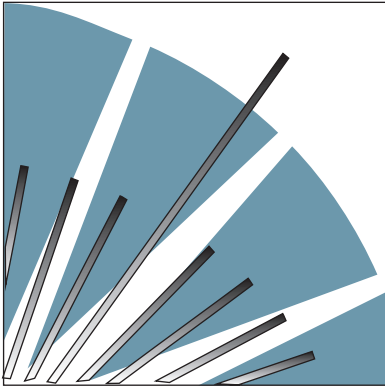

<b>Artwork Definitions</b>
----------------------------

<u>id</u>	<u>File</u>	<u>Page</u>	<u>References</u>
JORDAN	C2ABGSET	i	i

<b>Grid Definitions</b>
-------------------------

<u>id</u>	<u>File</u>	<u>Page</u>	<u>References</u>
COL2	C2ABGSET	i	8-1, 8-4, 8-6, 9-1, 9-3, 9-5, 9-6, 11-1, 11-2, 11-3, 11-4, 11-5, 11-10, 11-13, A-9
COL2X	C2ABGSET	i	

<b>Screen Definitions</b>
---------------------------

<u>id</u>	<u>File</u>	<u>Page</u>	<u>References</u>
SCR1	C2ABGSET	i	11-1
SCR2	C2ABGSET	i	
SCR3	C2ABGSET	i	
SCR4	C2ABGSET	i	8-1, 8-3, 8-3, 9-1, 9-1, 9-2, 9-2, 9-3, 9-3, 9-4, 9-5, 9-5, 9-6, 9-6, 9-7, 11-1, 11-2, 11-3, 11-3, 11-4
TOTOM	C2ABGSET	i	7-3, 7-5, 7-6, 7-8, 7-8, 8-1, 8-2, 8-2, 8-4, 8-5
FRAME1	C2ABGSET	i	8-5, 8-5
FRAME2	C2ABGSET	i	
TOTO3	C2ABGSET	i	9-6

<b>Table Definitions</b>
--------------------------

<u>id</u>	<u>File</u>	<u>Page</u>	<u>References</u>
CONV	C2ABGSET	i	1-4, 1-4
PWR2	C2ABGSET	i	
PWR3	C2ABGSET	i	
PWR4	C2ABGSET	i	
TOTO8	C2ABGSET	i	8-5, 11-10
TOTO9	C2ABGSET	i	
TOTO6	C2ABGSET	i	7-2, 7-7, 11-11, 11-11
TOTO4	C2ABGSET	i	7-3, 7-5
TOTO2	C2ABGSET	i	7-4
TOTO7	C2ABGSET	i	7-4, 7-5
TOTO5	C2ABGSET	i	7-1, 7-7, 8-1, 8-5, 9-6, 11-2, 11-12
TOTO1	C2ABGSET	i	7-1, 7-1, 7-2, 7-3, 7-6, 7-6, 7-6, 7-6, 7-6, 7-7, 7-7, 7-8, 7-8, 7-9, 8-1, 8-2, 8-3, 9-1, 9-2, 9-3, 9-4, 9-5, 9-5, 11-4, 11-5, 11-5, 11-5, 11-10, 11-12, 11-13
TOTO	C2ABGSET	i	
CPM1	C2ABGC04		

UNXC	C2XXXBIC	4-2	4-2, 4-2, 4-2, 4-2
TROISXC	C2XXXBIC	C-1	C-1, C-1, C-1, C-2, C-2, C-3, C-3, C-4, C-4
THREXC	C2XXXBIC	C-1	C-1, C-1, C-1, C-1, C-2, C-2, C-2, C-2, C-2, C-2, C-3, C-3, C-3, C-3, C-3, C-4, C-4, C-4, C-4
UNXCD	C2XXXBIC	C-1	C-1
TROIXCD	C2XXXBIC	C-5	C-5, C-5, C-5, C-5, C-5
CINQD	C2XXXBIC	C-5	C-5, C-5, C-5
		C-5	C-5

<b>Figures</b>
----------------

<u>id</u>	<u>File</u>	<u>Page</u>	<u>References</u>
OV025	C2ABGC01	1-2	1-1 1-1
CEXP	C2ABGC01	1-3	1-2 1-3
CONTROL	C2ABGC01	1-5	1-3 1-4
SHARCO1	C2ABGC02	2-2	2-1 2-3
SHARCO2	C2ABGC02	2-2	2-2 2-3
GOTME	C2ABGC03	3-1	3-1 3-1, 3-1, 3-9
FSRULES	C2ABGC03	3-13	3-3 3-10
LCB	C2ABGC03	3-17	3-6 3-17
CCMMW	C2ABGC05	5-2	5-1 5-2
IPE	C2ABGC06	6-5	6-2 6-4

<b>Headings</b>
-----------------

<u>id</u>	<u>File</u>	<u>Page</u>	<u>References</u>
NOTICES	NOTICES	ix	Notices ii
ABOUT	C2ABGFRO	xi	About This Guide
WHO	C2ABGFRO	xi	Who Should Use this Guide
NETEV	C2ABGC01	1-1	Chapter 1, General Information on 3745 and 3746 Controllers xii
ONEA	C2ABGC01	1-1	The IBM 3745 and 3746 Controllers Family
EPOS	C2ABGC01	1-4	Stop Switch for the 3745
IYHAP	C2ABGC01	1-5	Solving Problems 3-5, 3-10, 3-10, 8-5, 11-9, 11-9
SP	C2ABGC02	2-1	Chapter 2, Service Processor xii
SHARCON	C2ABGC02	2-2	Sharing the Service Processor

UDCAF	C2ABGC02	2-3	Using DCAF to Remotely Log On to the Service Processor
CUSTCO	C2ABGC02	2-3	Remote Consoles
BUYSP	C2ABGC02	2-4	Backing Up the Service Processor
BUCONFI	C2ABGC02	2-4	Backing Up Configurations to a Backup Service Processor 2-4
BUMOSSE	C2ABGC02	2-6	Installing Microcode to a Backup Service Processor 2-4
GS	C2ABGC03	3-1	Chapter 3, Maintenance and Operator Sub-System-Extended (MOSS-E) xii
MPASS	C2ABGC03	3-2	MOSS-E Passwords
SCEPLOG	C2ABGC03	3-4	Logging On to MOSS-E 2-4, 2-5, 3-1, 3-8, 3-10
SCEPOFF	C2ABGC03	3-6	Logging Off the MOSS-E
IPDM	C2ABGC03	3-7	Information Pull-Down Menu 4-10
HMENU	C2ABGC03	3-8	Help Pull-Down Menu xiii, 1-5, 3-5, 3-10, 3-10
L1A	C2ABGC03	3-8	MOSS-E Menus, Tasks, and Functions 3-5, 10-2, 11-7, 11-8
OPMOSSE	C2ABGC03	3-8	How to Use a Machine Menu 4-1, 5-4
NOTRUN	C2ABGC03	3-9	Problems with MOSS-E or the Service Processor 3-4, 3-5, 3-10
L1B	C2ABGC03	3-10	MOSS Window
OPMOSS	C2ABGC03	3-10	How to Open the MOSS Window 7-3, 7-5, 7-6, 8-1, 9-1, 9-3, 10-1, 11-1, 11-2
CONLAY	C2ABGC03	3-10	Service Processor MOSS Screen Layout
FKY	C2ABGC03	3-12	Common Commands and Function Keys
HSMOOS	C2ABGC03	3-13	Selecting MOSS Functions
FMENU	C2ABGC03	3-14	Menu 1 and 2 Functions 3-13, 3-13, 3-13
HSBF	C2ABGC03	3-15	Switching between Menu 1 and Menu 2 Functions
INTMOD3	C2ABGC03	3-16	Updating the Active CDF-E
CONFSAV	C2ABGC03	3-18	Backing up Controller Configurations 2-4, 3-18
WWTNNP	C2ABGC04	4-1	Chapter 4, Working with Network Node Processor (NNP) Functions xii
ATAF	C2ABGC04	4-1	Accessing NNP Functions
MCPON	C2ABGC04	4-1	Manage Control Points on NNPs 4-10
ACAO	C2ABGC04	4-2	Automatic Configuration Activation Option 4-3
MTCP	C2ABGC04	4-4	NNP Status 4-2, 4-10
CCMF	C2ABGC04	4-9	Controller Configuration and Management (CCM)
IPCOM	C2ABGC04	4-10	IP Commands
MAE	C2ABGC05	5-1	Chapter 5, Working with Multiaccess Enclosure (MAE) Functions

			xii
MAEHARD	C2ABGC05	5-1	MAE with Direct Attachment 5-1
MAECCM	C2ABGC05	5-2	MAE Configurations in CCM
CONFIG	C2ABGC05	5-3	Using the MAE Configuration Program
MAEFUN	C2ABGC05	5-4	Accessing MAE Functions
IMLMAE	C2ABGC05	5-6	Selective IML on MAE 5-5
AIRCM	C2ABGC06	6-1	Chapter 6, Telnet IP Resource Management in CCM and MOSS-E xii, 3-3, 4-9
CCM	C2ABGC06	6-1	Controller Configuration and Management (CCM)
USRPROF	C2ABGC06	6-1	CCM and Telnet User Profiles 6-4
CCMIP	C2ABGC06	6-2	CCM IP Resource Management 6-1
AICUM	C2ABGC06	6-4	Accessing IP Commands from the MOSS-E 4-10, 6-1
NWIPE	C2ABGC06	6-4	Navigating in the IP Environment 6-4
CIPR	C2ABGC06	6-5	Configuring Resources 6-4
MIPR	C2ABGC06	6-6	Managing Resources 6-4
WWMAE	C2ABGC06	6-7	Single IP Control Point for the 3746 and the MAE
MONITR	C2ABGC06	6-7	MONITR Process
POWERIP	C2ABGC07	7-1	Chapter 7, 3745 Power ON and IPL from Control Panel xii, 8-1
L7A1	C2ABGC07	7-1	3745 Manual Power ON and IPL
L8	C2ABGC07	7-6	3745 Automatic Power ON and IPL
THREE	C2ABGC08	8-1	Chapter 8, 3745 IPL from Service Processor xii, 8-5, 11-2
UNUSBLE	C2ABGC08	8-4	Troubleshooting Channel Adapters and IPL Ports
L11	C2ABGC08	8-6	Information Displayed on the MOSS Screen during IPL 9-3
FBANDSB	C2ABGC09	9-1	Chapter 9, 3745 Models 41A and 61A Fallback and Switchback xii
L3	C2ABGC09	9-1	Fallback
L4	C2ABGC09	9-3	Switchback 9-2
L6	C2ABGC10	10-1	Chapter 10, Enabling and Disabling Channel Adapters xii, 7-5
ENESC	C2ABGC10	10-2	Enabling and Disabling 3746-900 ESCON Channel Adapters 7-3
CHESCC	C2ABGC10	10-2	Verifying an ESCON Coupler Status
CHIPL	C2ABGC10	10-4	Verifying a Link IPL Port
IML	C2ABGC11	11-1	Chapter 11, Basic Service Procedures xii, 1-3, 1-3
L5A	C2ABGC11	11-1	3745 MOSS IML from the Service Processor
L5B	C2ABGC11	11-2	3745 Scanner (Line Adapter) IML

L10A	C2ABGC11	11-4	MOSS IML from the 3745 Control Panel A-4
PCMS	C2ABGC11	11-6	3746 Power State
POOM	C2ABGC11	11-7	Activation/Deactivation from the Service Processor 11-7
TPON	C2ABGC11	11-7	Activation 11-9, 11-14
TPOFF	C2ABGC11	11-8	Deactivation 11-9
ADFH	C2ABGC11	11-9	Activation/Deactivation from a Host 11-7
MPO	C2ABGC11	11-10	Activation and IML from the 3746 Operator Control Panel 11-6, B-2
OCP3745	C2ABGAPA	A-1	Appendix A, 3745 Operator Control Panel xiii, 1-4, 7-1
POWCTRL	C2ABGAPA	A-5	Power Control Display 7-6
L13	C2ABGAPA	A-9	Hexadecimal Codes 7-2, 7-4, 7-4, 11-6
CPIHC	C2ABGAPB	B-1	Appendix B, 3746 Operator Control Panel xiii, 1-3, 1-4, 11-10
FD	C2ABGAPB	B-1	Function Display
FBUT	C2ABGAPB	B-2	Selections Using the Function Button
CBCDISC	C2ABGAPB	B-3	8 - CBC/ESCC logical disconnection B-2
SM	C2ABGAPB	B-3	Service Mode B-2
PWC	C2ABGAPB	B-4	Power Control
ACD	C2ABGAPB	B-4	All ESCON Channel Adapters Disabled
CNA	C2ABGAPB	B-5	Service Processor Inaccessible 11-12
BIBL	C2ABGAPC	C-1	Appendix C, Bibliographies xii, xiii
MANBIC	C2XXXBIC	C-1	Customer Documentation for the 3745 (Models 210, 310, 410, 610, 21A, 31A, 41A, and 61A), and 3746 (Model 900) xiii
DEGBIC	C2XXXBIC	C-5	Additional Customer Documentation for the 3745 Models 130, 150, 160, 170, and 17A xiii

List Items			
------------	--	--	--

<u>id</u>	<u>File</u>	<u>Page</u>	<u>References</u>
WL	C2ABGC03	3-4	2 3-16, 3-19, 5-2, 6-1, 6-2, 6-4
PGM	C2ABGC03	3-5	3 3-4
TON	C2ABGC03	3-9	1 3-9
POWON	C2ABGC03	3-9	2 3-9
CVLCBS	C2ABGC03	3-17	5







<b>Processing Options</b>
---------------------------

## Runtime values:

Document fileid .....	C2ABGC00 SCRIPT
Document type .....	USERDOC
Document style .....	AGDTEMP
Profile .....	EDFPRF40
Service Level .....	0030
SCRIPT/VS Release .....	4.0.0
Date .....	98.05.16
Time .....	18:38:45
Device .....	PSA
Number of Passes .....	3
Index .....	YES
SYSVAR G .....	INLINE
SYSVAR V .....	LOCBLBOK
SYSVAR X .....	YES

## Formatting values used:

Annotation .....	NO
Cross reference listing .....	YES
Cross reference head prefix only .....	NO
Dialog .....	LABEL
Duplex .....	YES
DVCF conditions file .....	(none)
DVCF value 1 .....	(none)
DVCF value 2 .....	(none)
DVCF value 3 .....	(none)
DVCF value 4 .....	(none)
DVCF value 5 .....	(none)
DVCF value 6 .....	(none)
DVCF value 7 .....	(none)
DVCF value 8 .....	(none)
DVCF value 9 .....	(none)
Explode .....	NO
Figure list on new page .....	YES
Figure/table number separation .....	YES
Folio-by-chapter .....	YES
Head 0 body text .....	(none)
Head 1 body text .....	Chapter
Head 1 appendix text .....	Appendix
Hyphenation .....	NO
Justification .....	NO
Language .....	ENGL
Keyboard .....	395
Layout .....	OFF
Leader dots .....	YES
Master index .....	(none)
Partial TOC (maximum level) .....	4
Partial TOC (new page after) .....	INLINE
Print example id's .....	NO
Print cross reference page numbers .....	YES
Process value .....	(none)
Punctuation move characters .....	,
Read cross-reference file .....	(none)
Running heading/footer rule .....	NONE
Show index entries .....	NO
Table of Contents (maximum level) .....	3
Table list on new page .....	NO
Title page (draft) alignment .....	RIGHT
Write cross-reference file .....	(none)

Named Files
-------------

<u>Fileid</u>	<u>Page</u>	<u>Data Set Name</u>
C2ACOUV2	14	C2ACOUV2 EPSBIN

Imbed Trace
-------------

Page 0	C2ABGSET
Page 0	C2ABGFRO
Page vii	NOTICES
Page ix	EUSTATE
Page x	CANFCCA
Page x	JAPVCCI1
Page x	KORFCCA
Page x	NZFCCA
Page xiv	C2ABGC01
Page 1-5	C2ABGC02
Page 2-7	C2ABGC03
Page 3-19	C2ABGC04
Page 4-10	C2ABGC05
Page 5-6	C2ABGC06
Page 6-7	C2ABGC07
Page 7-3	C2AZSI33
Page 7-6	C2AZSI33
Page 7-8	C2AZSI46
Page 7-8	C2AZSI46
Page 7-9	C2ABGC08
Page 8-1	C2AZSI02
Page 8-2	C2AZSI32
Page 8-2	C2AZSI04
Page 8-6	C2AZSI05
Page 8-8	C2ABGC09
Page 9-1	C2AZSI07
Page 9-1	C2AZSI09
Page 9-1	C2AZSI13
Page 9-2	C2AZSI08
Page 9-2	C2AZSI45
Page 9-3	C2AZSI15
Page 9-3	C2AZSI16
Page 9-4	C2AZSI17
Page 9-5	C2AZSI18
Page 9-5	C2AZSI19
Page 9-6	C2AZSI20
Page 9-6	C2AZSI31
Page 9-6	C2AZSI21
Page 9-7	C2ABGC10
Page 10-4	C2ABGC11
Page 11-1	C2AZSI22
Page 11-1	C2AZSI33
Page 11-2	C2AZSI23
Page 11-2	C2AZSI24
Page 11-3	C2AZSI25
Page 11-3	C2AZSI26
Page 11-14	C2ABGAPA
Page A-10	C2ABGAPB
Page B-5	C2ABGAPC
Page C-1	C2XXXBIC
Page C-6	C2ABGABR
Page X-2	C2ABGGLO
Page X-9	RCFADDR
Page X-11	RCFADDR
Page 14	COUV2